



基础器械

ORTHOPEDICS INSTRUMENTS



四川辰安汇科技有限公司
Sichuan ChenAnHui Technology Co.,Ltd

Sichuan ChenAnHui Technology Co., Ltd.

- Email: jeyxx0313@163.com
- Address: Room 1903A, 19th Floor, Building 1, No. 595, Jinzhou Road, Jinniu High-tech Industrial Park, Chengdu City, Sichuan Province.

目录 Contents

各类螺钉盒 All Kinds Of Screws Box	P01-06	下肢创伤钢板手术工具(简易) Large Bone Fracture Locking Plate Instrument(Simple)	P57
髓核钳 Nucleus Pulposus Clamp	P07-08	手指骨折内固定安装器械包 Finger Surgery Instruments Set	P58-60
椎板咬骨钳 Laminectomy Rongeurs	P09-11	鹅头钉安装器械包 DHS/DCS Instruments Set	P61-63
双(单)关节咬骨钳(剪) Double(Single) Action Rongeurs(Scissors)	P12-16	重建钢板手术器械包 Reconstruction Plate Operation Instrument	P64-66
各类钳子 All Kinds Of Pliers	P17-22	断钉取出器械包 Broken Screw Removal Instrument Set	P67-69
医用拉钩 Retractor	P23-28	脊柱内固定器械包 Spinal System Instruments Set	P70-72
骨刀 Osteotome	P29-31	脊柱融合器(多孔型)器械包 Spinal Fusion Device Kit(Multi Pass)	P73-74
骨刮匙 Bone Curette	P32-33	椎间融合器器械包 Vertebral Fusion Device Instrument Kit	P75-76
牵开器、牵引器 Retractor、tractor	P34-35	颈椎前路钢板安装器械包 Anterior Cervical Plate Mounting Kit	P77-78
其他 Other	P36-40	颈椎后路钢板安装器械包 Posterior Cervical Plate Instruments Set	P79-81
妇科器械 Womb Operating Instruments	P41	肋骨器械包 Encircling Plate Instrument Set	P82-83
φ 4.5空心钉安装器械包 Φ4.5 Cannulated Screw Instrument Set	P42-43	弹性髓内钉安装器械包 Elastic Intramedullary Nail Instrument Set	P84-85
φ 7.3空心钉安装器械包 Φ7.3 Cannulated Screw Instrument Set	P44-45	椎间盘铰刀器械包 Intervertebral Disc Reamer Instrument Set	P86-87
上肢骨折手术器械包(大套) Small Fragment Instrument Set(Full)	P46-48	颈椎前路专用手术器械包 Anterior Cervical Surgical Instruments Set	P88
上肢骨折手术器械包(简易) Small Fragment Instruments Set(Simple)	P49	颈椎后路专用手术器械包 Posterior Cervical Surgical Instruments Set	P89-90
上肢创伤钢板手术工具(大套) Small Bone Fracture Locking Plate Instrument(Full)	P50	颈椎后路专用手术器械包(一) Posterior Spinal Surgical Instruments Set	P91
上肢创伤钢板手术工具(简易) Small Bone Fracture Locking Plate Instrument(Simple)	P51	颈椎后路专用手术器械包(二) Posterior Spinal Surgical Instruments Set	P92
下肢骨折手术器械包(大套) Large Fragment Instruments Set(Full)	P52-54	椎间盘切除专用手术器械 Intervertebral Disc Surgical Instruments Set	P93
下肢骨折手术器械包(简易) Large Fragment Instruments Set(Simple)	P55	踝关节器械包 Ankle Instrument Set	P94-97
下肢创伤钢板手术工具 Large Bone Fracture Locking Plate Instrument	P56	枪式复位钳 Gun Type Reduction Forceps	P98

11001.01
上肢螺钉盒(小)
The Upper Screw Box (Small)



11003.01
上肢螺钉盒(大)
The Upper Screw Box (Large)



11002.01
下肢螺钉盒(小)
Lower Extremity Screw Box (Small)



11004.01
下肢螺钉盒(大)
Lower Extremity Screw Box (Large)



11005.01
手指螺钉盒(大)
Finger Screw Box(Large)

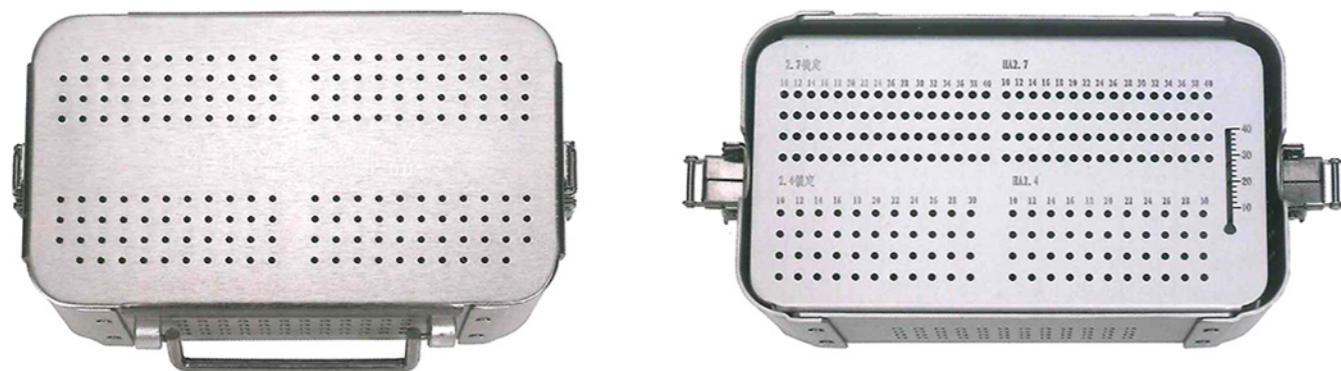

11007.01
上肢锁定螺钉盒(小)
The Upper Limb Locking Screw Box (Small)



11006.01
手指螺钉盒(小)
Finger Screw Box(Small)

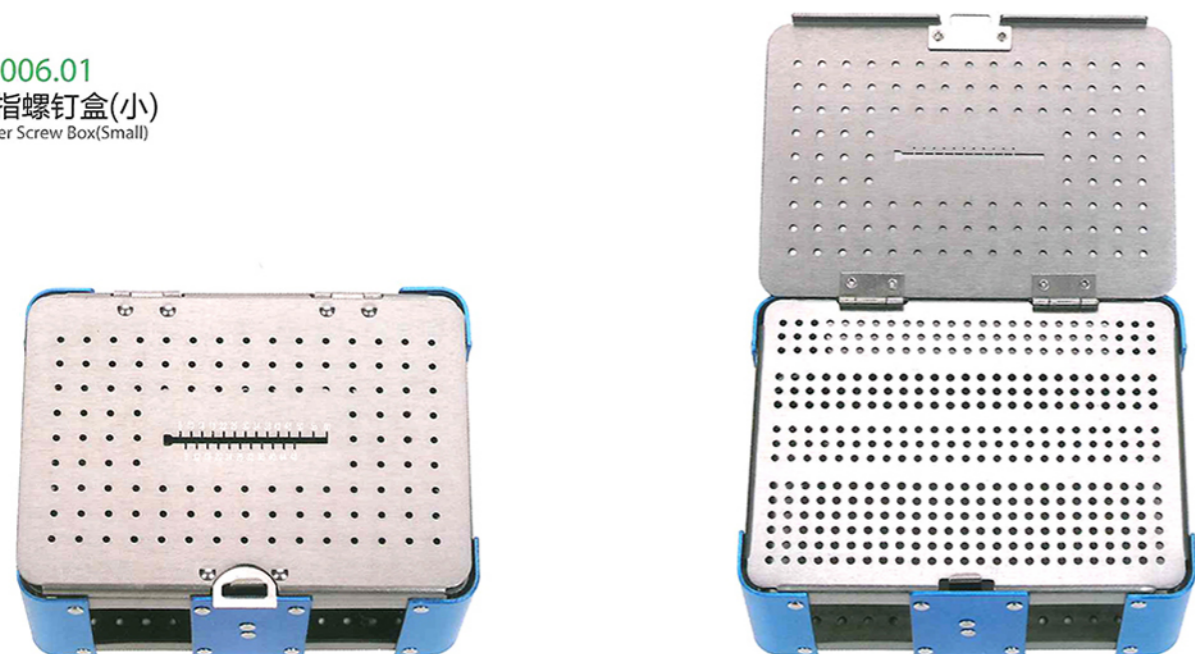

11008.01
下肢锁定螺钉盒(小)
Lower Limb Locking Screw Box (Small)

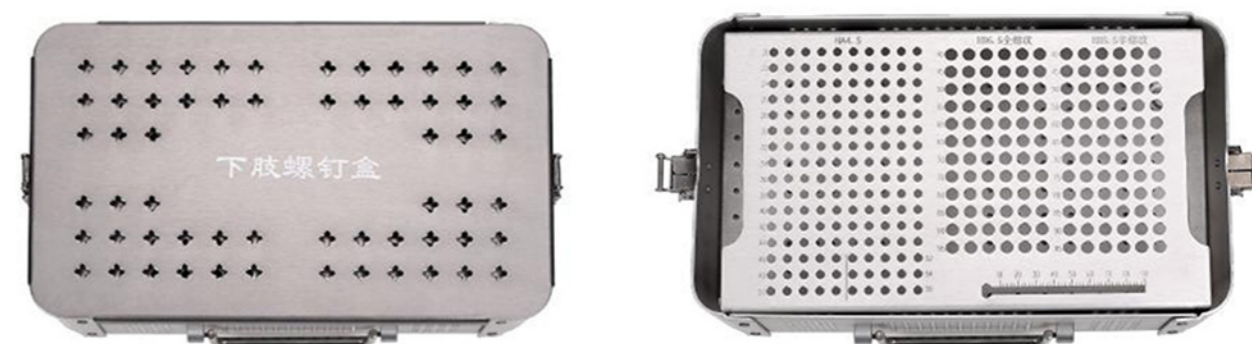

11007.02

上肢锁定螺钉盒(大)
The Upper Limb Locking Screw Box (Large)



11009.01

脊柱内固定螺钉盒
Spinal Screw Box



11008.02

下肢锁定螺钉盒(大)
Lower Limb Locking Screw Box (Large)



11010.01

克氏针消毒盒
K-wires Needle Sterilizing Box



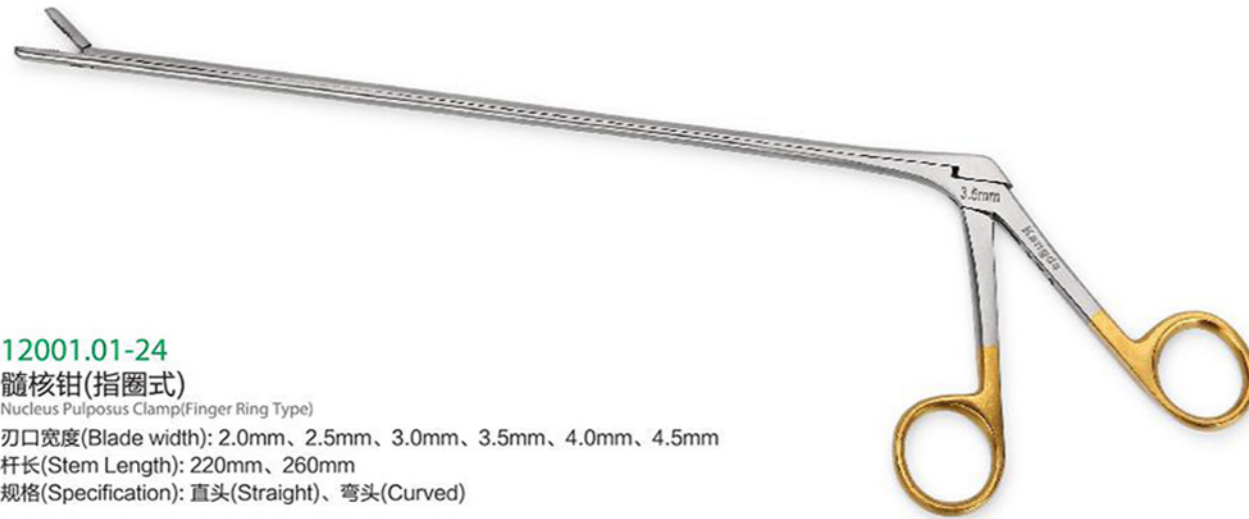

12001.01-24

髓核钳(指圈式)

Nucleus Pulposus Clamp(Finger Ring Type)

刃口宽度(Blade width): 2.0mm、2.5mm、3.0mm、3.5mm、4.0mm、4.5mm

杆长(Stem Length): 220mm、260mm

规格(Specification): 直头(Straight)、弯头(Curved)

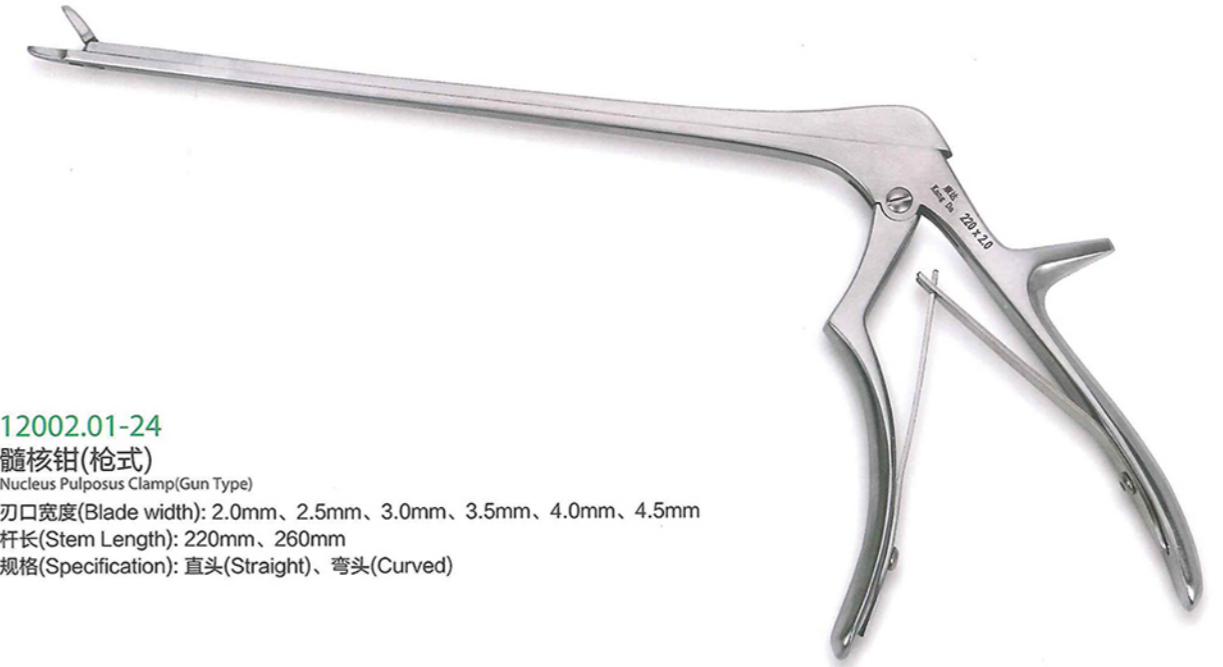
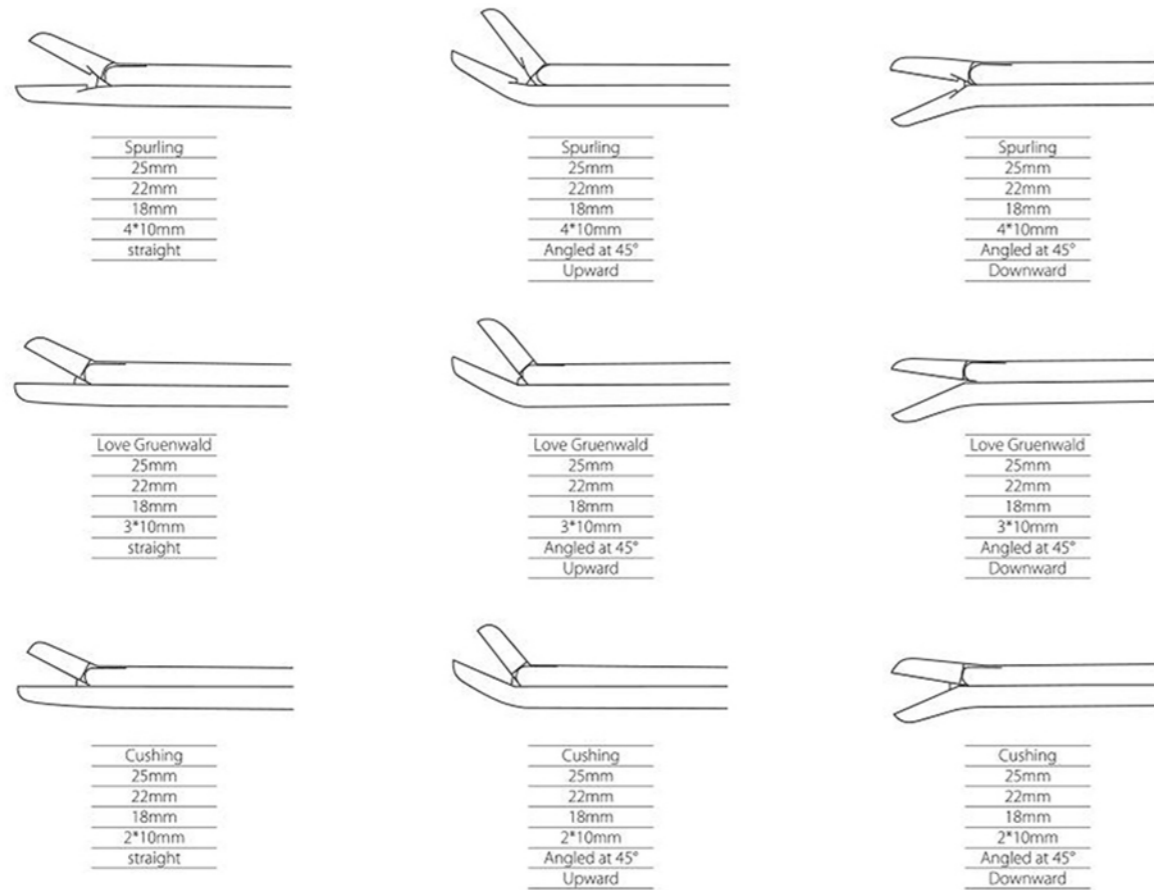

12002.01-24

髓核钳(枪式)

Nucleus Pulposus Clamp(Gun Type)

刃口宽度(Blade width): 2.0mm、2.5mm、3.0mm、3.5mm、4.0mm、4.5mm

杆长(Stem Length): 220mm、260mm

规格(Specification): 直头(Straight)、弯头(Curved)

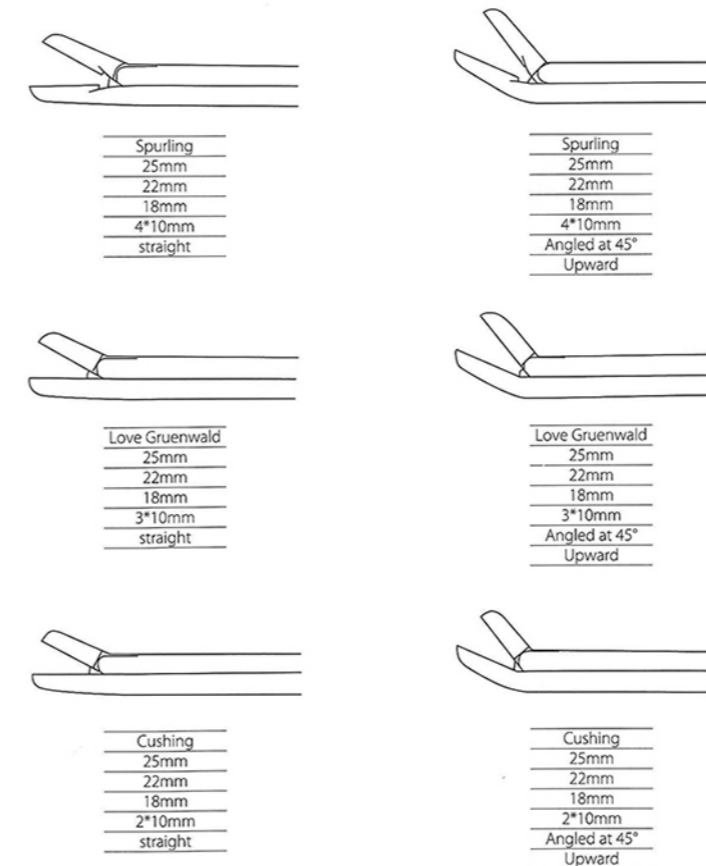

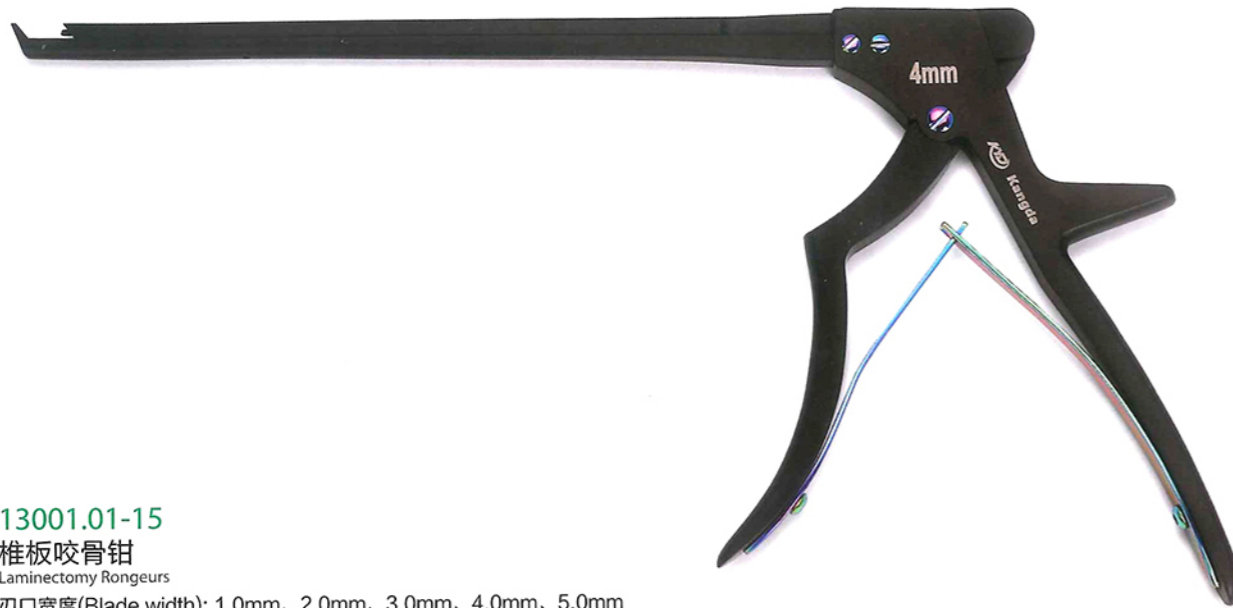

13001.01-15

椎板咬骨钳

Laminectomy Rongeurs

刃口宽度(Blade width): 1.0mm、2.0mm、3.0mm、4.0mm、5.0mm

刃口角度(Blade Mouth): 90°、110°、130°

杆长(Stem Length): 220mm

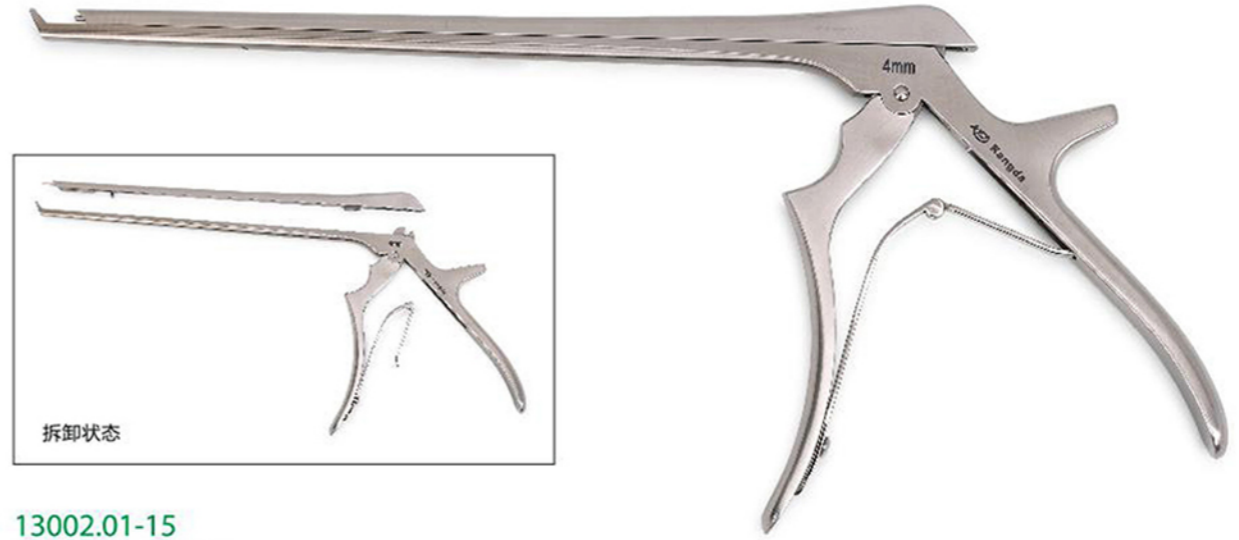
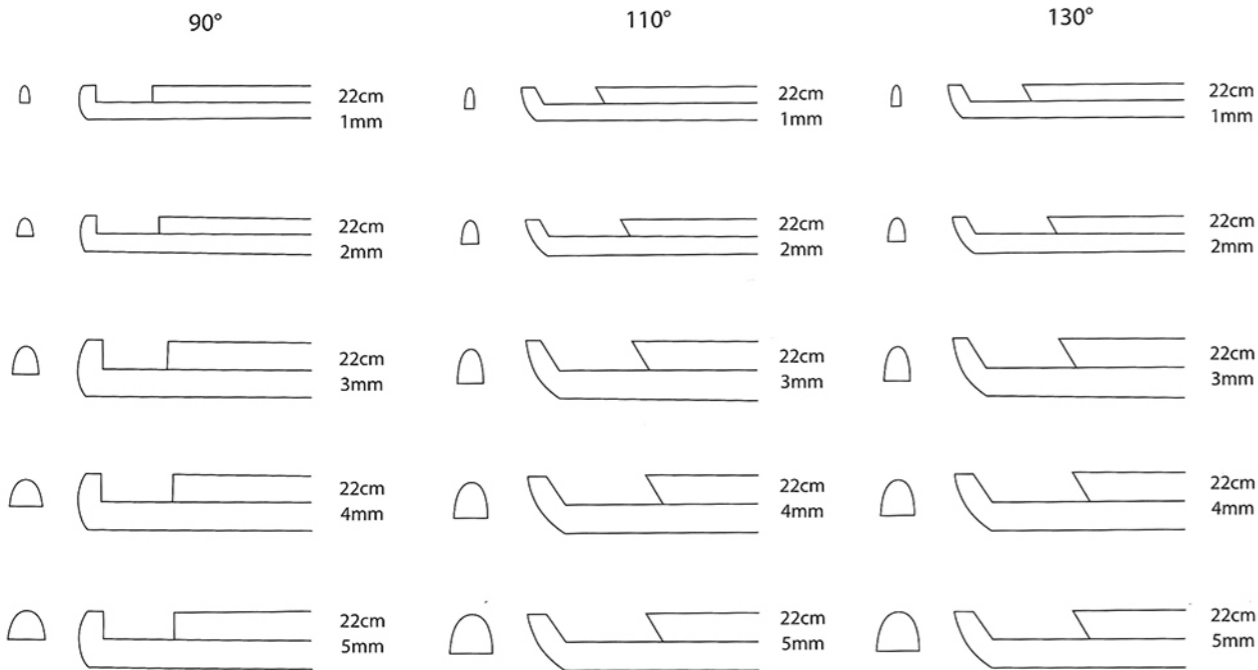

13002.01-15

可拆卸椎板咬骨钳

Laminectomy Rongeurs(Removable)

刃口宽度(Blade width): 1.0mm、2.0mm、3.0mm、4.0mm、5.0mm

刃口角度(Blade Mouth): 90°、110°、130°

杆长(Stem Length): 220mm



13003.01-15

360° 可旋转椎板咬骨钳

Laminectomy Rongeurs

刃口宽度(Blade width): 1.0mm、2.0mm、3.0mm、4.0mm、5.0mm

刃口角度(Blade Mouth): 90°、110°、130°

杆长(Stem Length): 220mm



13004.01-48

椎板咬骨钳

Laminectomy Rongeurs

刃口宽度(Blade width): 1.0mm、1.5mm、2.0mm、2.5mm、
3.0mm、3.5mm、4.0mm、4.5mm

刃口角度(Blade Mouth): 90°、110°、130°

杆长(Stem Length): 220mm

13005.01-48

椎板咬骨钳(镀金)

Laminectomy Rongeurs(Gilded)

刃口宽度(Blade width): 1.0mm、1.5mm、2.0mm、2.5mm、
3.0mm、3.5mm、4.0mm、4.5mm

刃口角度(Blade Mouth): 90°、110°、130°

杆长(Stem Length): 220mm

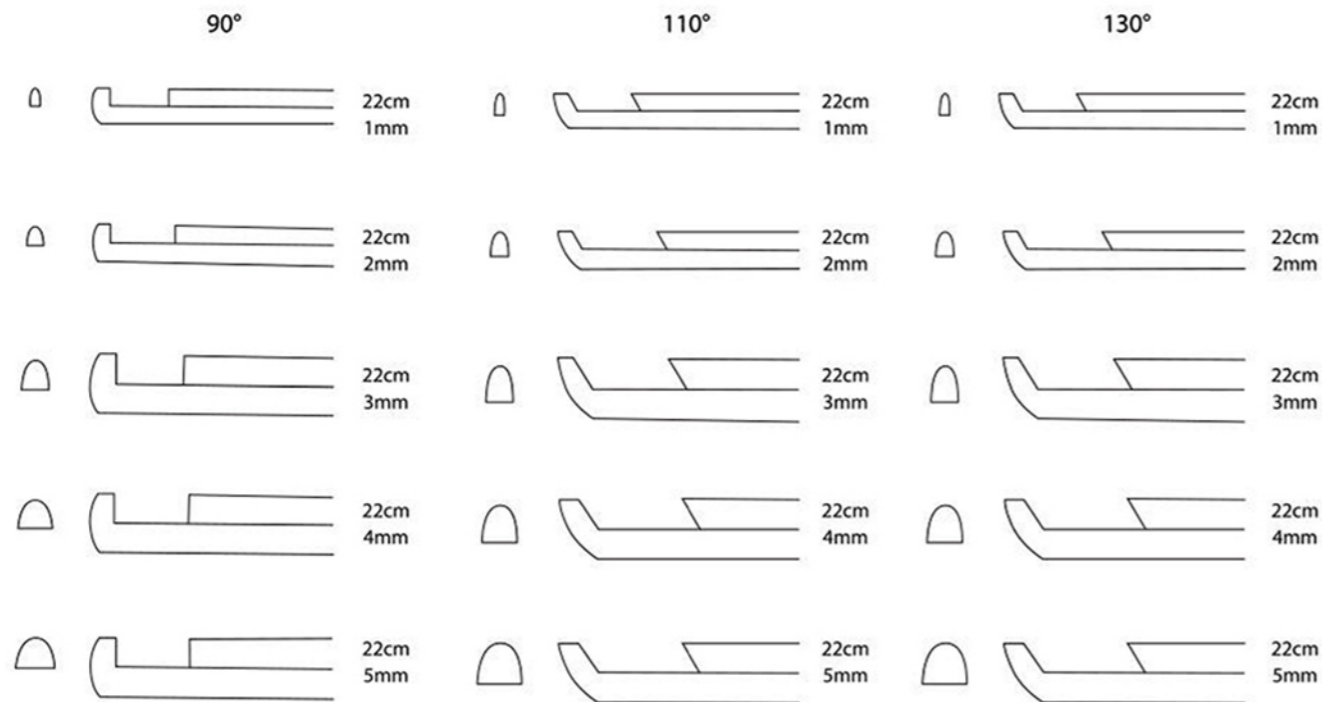

14001.01-04

单关节咬骨剪

Single-joint Bone Scissors

全长(Length): 140mm、180mm

规格(Specification): 直头(Straight)、弯头(Curved)

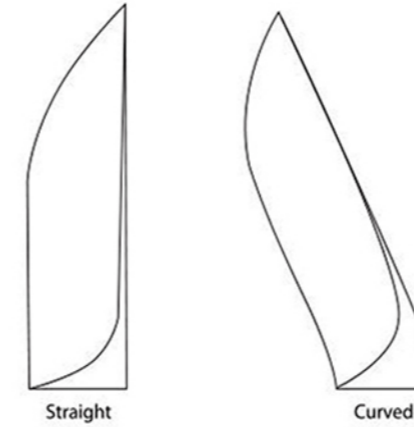

14002.01-20

单关节咬骨钳

Single-joint Pliers

刃口宽度(Blade width): 2mm、3mm、4mm、5mm、8mm

全长(Length): 140mm、180mm

规格(Specification): 直头(Straight)、弯头(Curved)

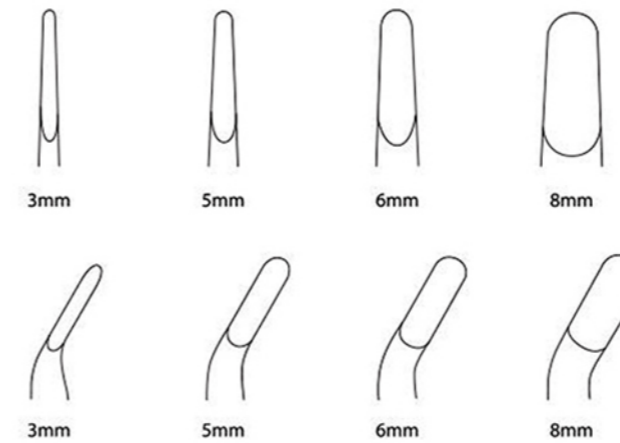

14003.01-04

双关节咬骨剪

Double joint Bone Scissors

全长(Length): 180mm、230mm

规格(Specification): 直头(Straight)、弯头(Curved)

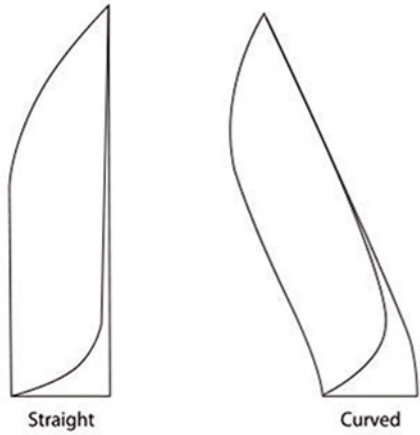

14005.01-42

双关节咬骨钳

Double Action Bone Rongeurs

刃口宽度(Blade width): 2mm、3mm、4mm、5mm、8mm

全长(Length): 160mm、180mm、220mm、240mm

规格(Specification): 直圆(Straight)、微弯(Microbend)、尖弯(Sharp bends)

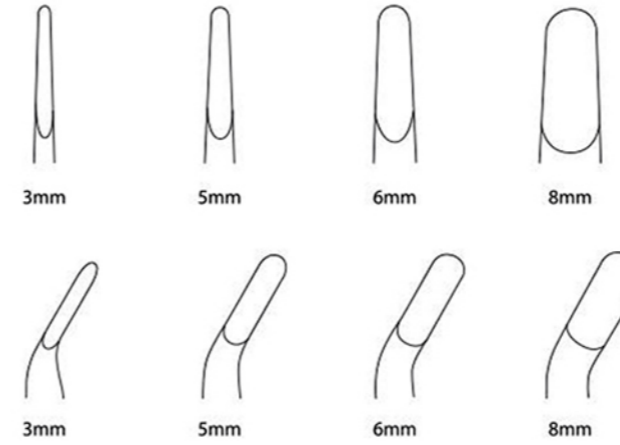

14004.01-03

棘突双关节咬骨剪

Spinous Double Joint Scissors

规格(Specification): 直圆(Straight)、微弯(Curved)、90° 弯曲(90° Curved)

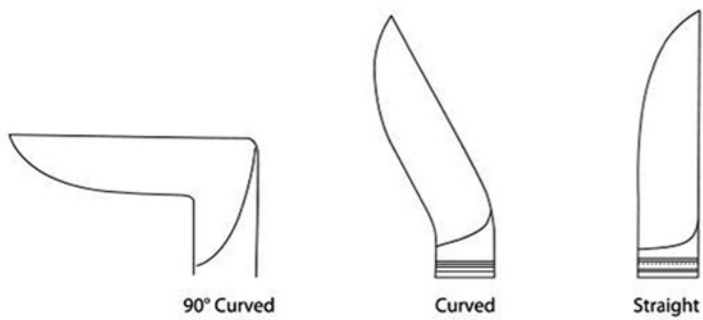

14006.01-15

双关节咬骨钳(镀金)

Double Action Bone Rongeurs(Gilded)

刃口宽度(Blade width): 2mm、3mm、4mm、5mm、8mm

全长(Length): 240mm

规格(Specification): 直圆(Straight)、微弯(Microbend)、尖弯(Sharp bends)

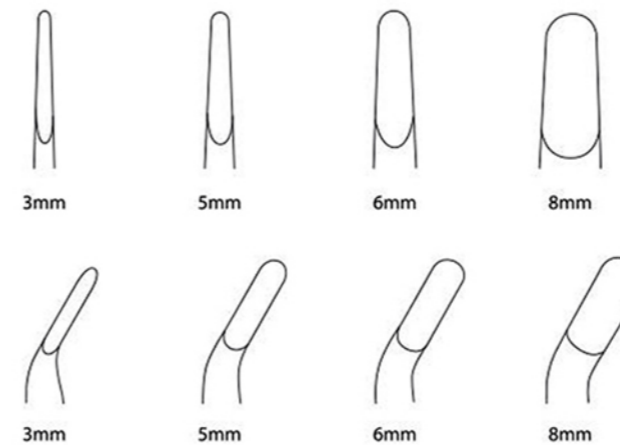

14007.01-12

双关节咬骨钳(尖型)

Double Action Bone Rongeurs(Tip)

刃口宽度(Blade width): 3mm

全长(Length): 160mm、180mm、220mm、240mm

规格(Specification): 直(Straight)、微弯(Microbend)、尖弯(Sharp bends)

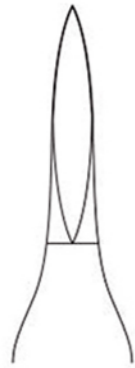

14009.01-42

棘突双关节咬骨钳

Double Action Bone Rongeurs

刃口宽度(Blade width): 16mm

全长(Length): 260mm

规格(Specification): 直头(Straight)、弯头(Curved)

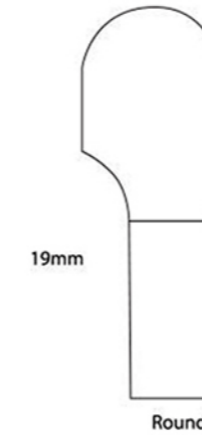

14008.01-05

侧弯双关节咬骨钳

Spurling Rongeurs

全长(Length): 240mm

规格(Specification): 2mm、3mm、4mm、5mm、8mm

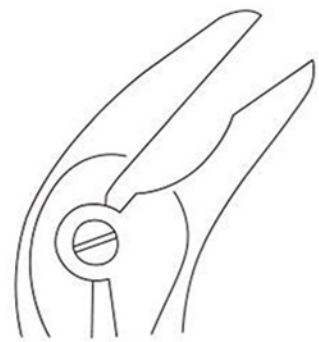

侧弯鹰嘴咬骨钳
Echlin 23cm



2mm



3mm



4mm



14006.01-15

枪型双关节咬骨钳

Gun-type Double Joint Rongeur

刃口宽度(Blade width): 2mm、3mm、4mm、5mm、6mm、7mm、8mm

全长(Length): 260mm、320mm

规格(Specification): 直头(Straight)



2x16mm



3x16mm



4x16mm



5x16mm



7x16mm



10x16mm



15008.02
医用钢丝钳(平头)新型
Stainless Cutting Pliers



15008.01
医用钢丝钳(平头)
Stainless Cutting Pliers



15003.01
斜口钳
Oblique Clamp



15003.02
斜口钳(带弹簧)
Oblique Clamp

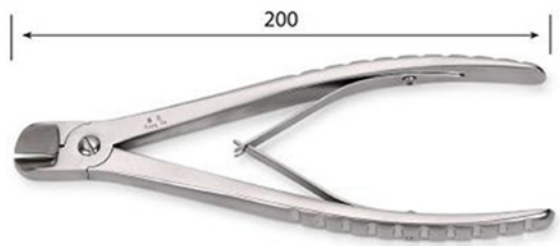

15003.03
钢针剪
Wire Cutter
规格(Specification): 200 × 1.2mm



15009.01
医用钢丝钳(尖头)
Sharp-crested Clipper



15005.01
大力剪
Wire Cutter 1



15004.01
小力剪
Wire Cutter 2

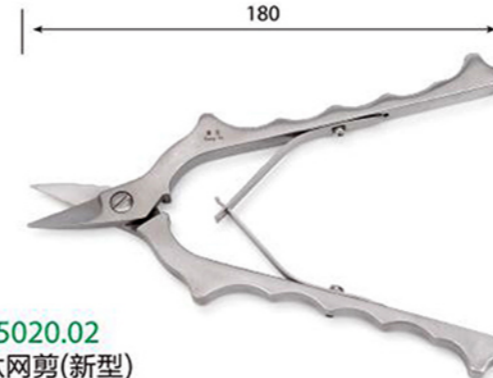

15020.02
钛网剪(新型)
Titanium Forceps



15020.01
钛网剪
Titanium Forceps



15007.01
3.0钢针剪
Wire Cutter 3.0

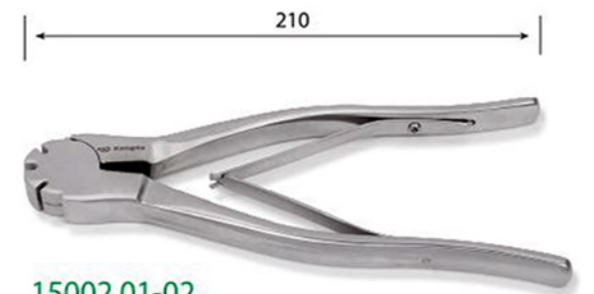

15002.01-02
圆头克氏剪(开口)(闭口)
Wire Cutter

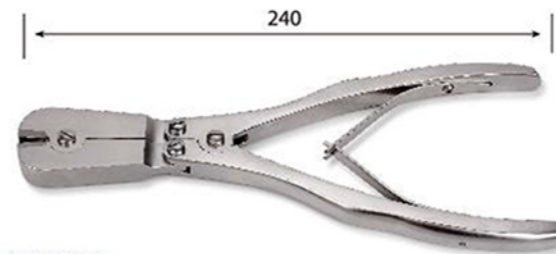

1506.01
钢针剪
Wire Cutter



15002.03
圆头克氏剪(新型)
Wire Cutter



15001.02
顶切型钢针剪
Wire Cutter

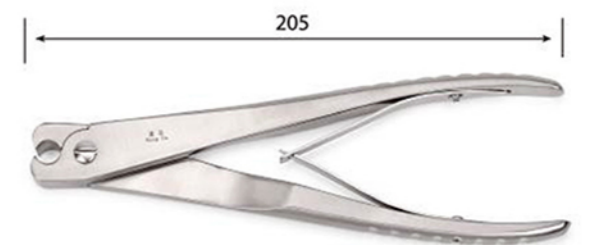

15001.01
顶切型钢针剪
Wire Cutter



15030.01
钢针剪 I 型
Wire Cutter



15030.02
钢针剪 II 型
Wire Cutter



15030.03
钢针剪 III 型
Wire Cutter



15030.06
钢针剪 VI 型
Wire Cutter



15030.05
钢针剪 V 型
Wire Cutter



15030.04
钢针剪 IV 型
Wire Cutter



15030.07
钢针剪 VII 型
Wire Cutter



15030.09
钢针剪 IX 型
Wire Cutter



15030.12
大力剪
Wire Cutter 1



15030.13
断棒钳
Rod Cutter



15025.01
持针钳
Wire Holder



15030.08
紧丝钳
Tight Wire Pliers



15030.10
石膏撑开钳
Plaster Retractor



15030.11
持骨钳
Bone Holding Forcep



15018.01-02
骨圆针折弯钳(大号/小号)
Kirschner Plate Bending Forceps



15019.01
棘突打孔器
Spinous Punch



15023.01
四齿持骨钳
Bone Holding Forceps(Four Teeth)



15024.01
二齿持骨钳
Bone Holding Forceps(Two Teeth)



15013.01
肩关节撑开钳(右)
Distractor



15013.02
肩关节撑开钳(左)
Distractor



15021.01
钢丝引导钳
Wire Guider



15022.01
尾钉折断钳
Wire Plier



15012.01
膝关节撑开钳(平口)
Knee Distractor



15012.02
膝关节撑开钳(八字口)
Knee Distractor



15010.01
平行压缩钳
Parallel Compression Forceps



15011.01
平行撑开钳
Parallel Spreader Forceps



15016.01
髌骨钳
Pateaur Clamp
全长(Length): 190mm



15017.01-02
强力持棒钳(大号/小号)
Strong Rod Holding Clamp

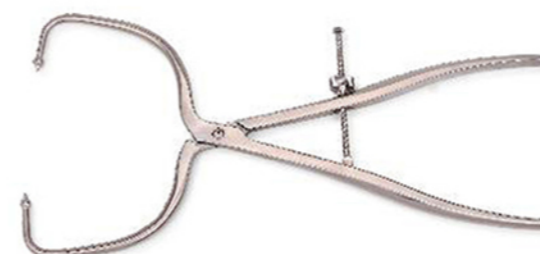

15015.01
胫骨平台复位钳
The tibia platform reset pliers



15014.01
胫骨平台复位钳(单孔)
The tibia platform reset pliers



16001.01
肌肉拉钩
Bone Elevator
规格(Specifications): 大号(Large size)、小号(Small size)



16001.02-03
肌肉拉钩(钉耙式)
Bone Elevator
规格(Specifications): 三齿(3 teeth)、四齿(4 teeth)



16002.01-02
颈椎S型拉钩
Nerve Elevator
规格(Specifications): 大号(Large size)、小号(Small size)



16003.01-02
颈椎拉钩
Nerve Elevator
规格(Specifications): 大号(Large size)、小号(Small size)



16007.01-09
神经根拉钩(板材式)
Nerve Retractor
头部宽度(Head Width): 3mm、5mm、7mm
角度 α (The Angle of α): 90°、135°、180°



16008.01-09
神经根拉钩(胶木式)
Nerve Retractor
头部宽度(Head Width): 3mm、5mm、7mm
角度 α (The Angle of α): 90°、135°、180°



16004.01-02
椎板拉钩
Laminectomy Retractor
规格(Specifications): 大号(Large size)、小号(Small size)



16005.01
甲状腺拉钩
Thyroid Retractor
规格(Specifications): 大号(Large size)、小号(Small size)



16010.01
髋臼拉钩I型
Acetabulum Retractor I

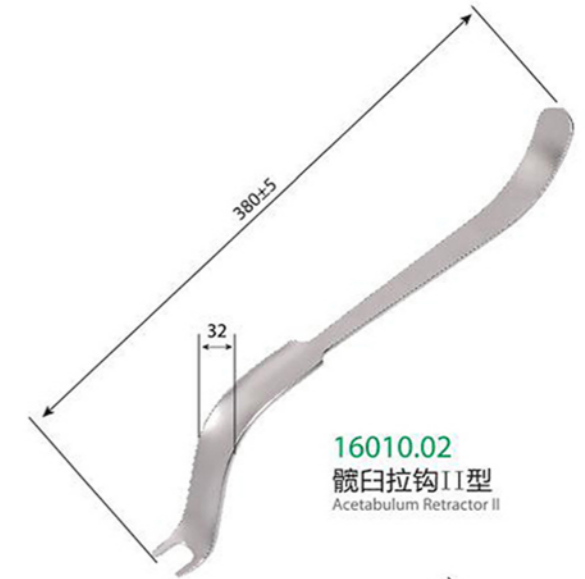

16010.02
髋臼拉钩II型
Acetabulum Retractor II

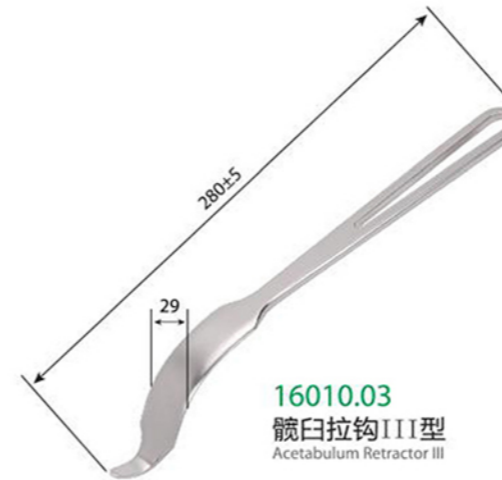

16010.03
髋臼拉钩III型
Acetabulum Retractor III



16010.04
髋臼拉钩IV型
Acetabulum Retractor IV

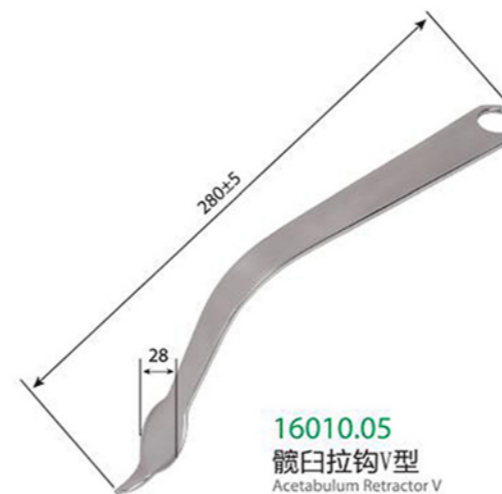

16010.05
髋臼拉钩V型
Acetabulum Retractor V



16010.06
髋臼拉钩VI型
Acetabulum Retractor VI

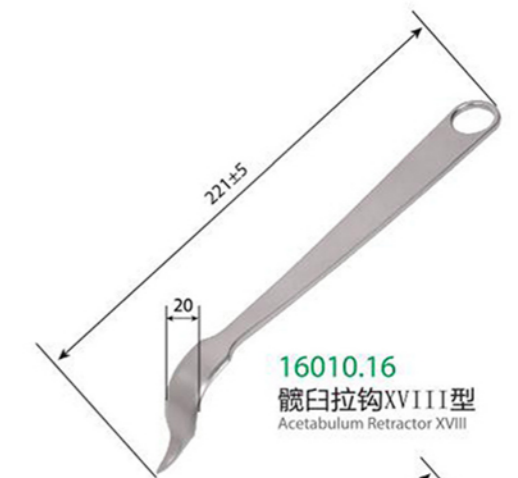
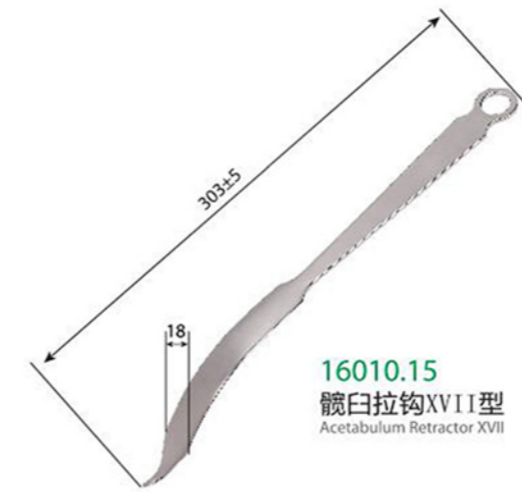
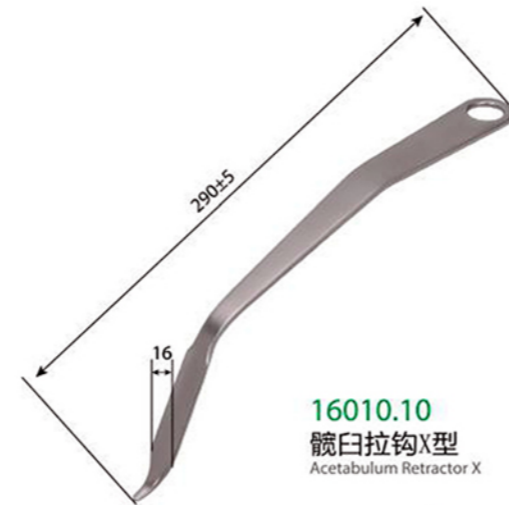
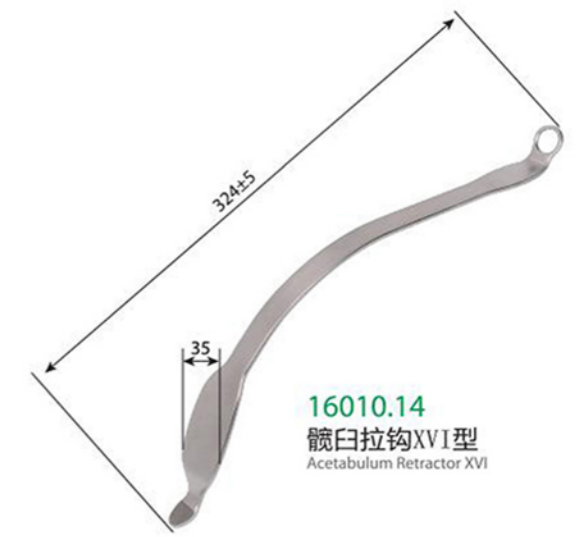
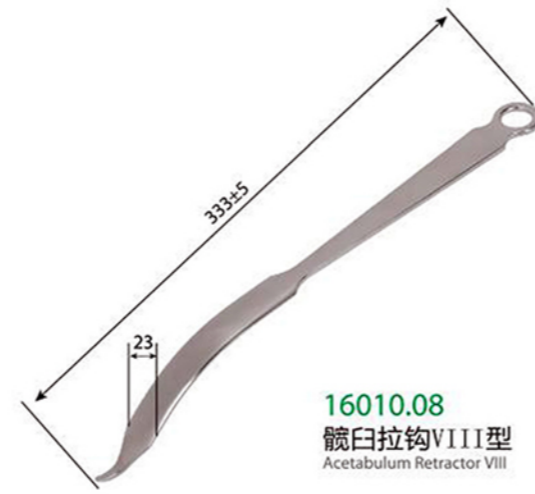

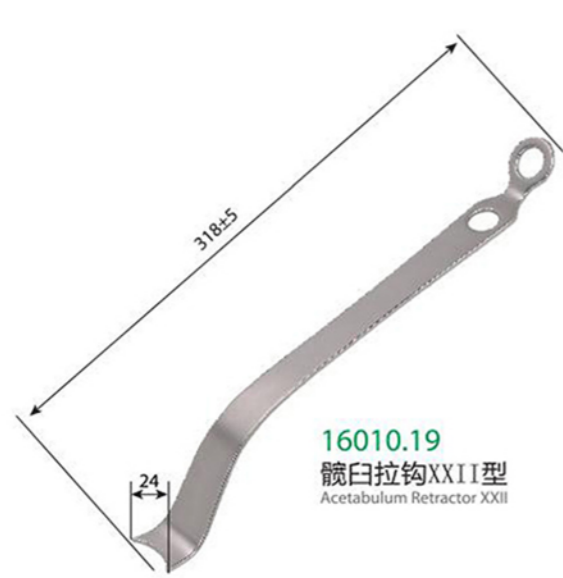

16010.19
髌臼拉钩XXII型
Acetabulum Retractor XXII

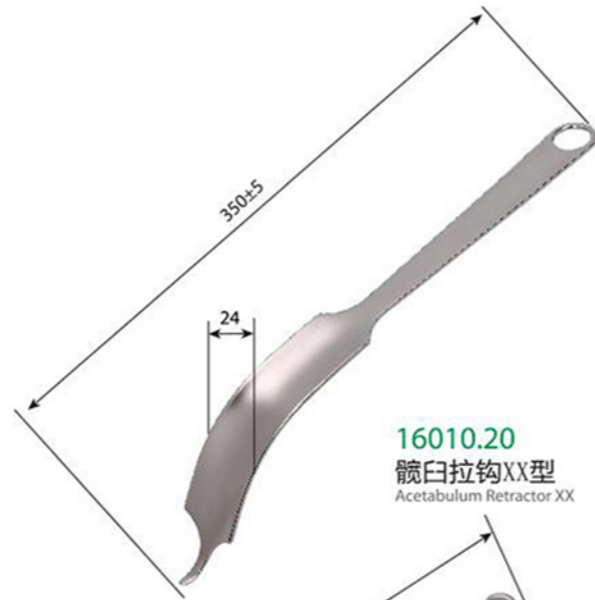

16010.20
髌臼拉钩XX型
Acetabulum Retractor XX



16009.06
膝关节单齿侧副韧带拉钩
The Ruptured Collateral Ligament of The Knee Joint of Single Tooth Retractor



16009.07
膝关节二齿侧副韧带拉钩
The Ruptured Collateral Ligament of The Knee Joint Bidentate Retractor



16009.01
Z型膝关节拉钩
Z Knee Retractor

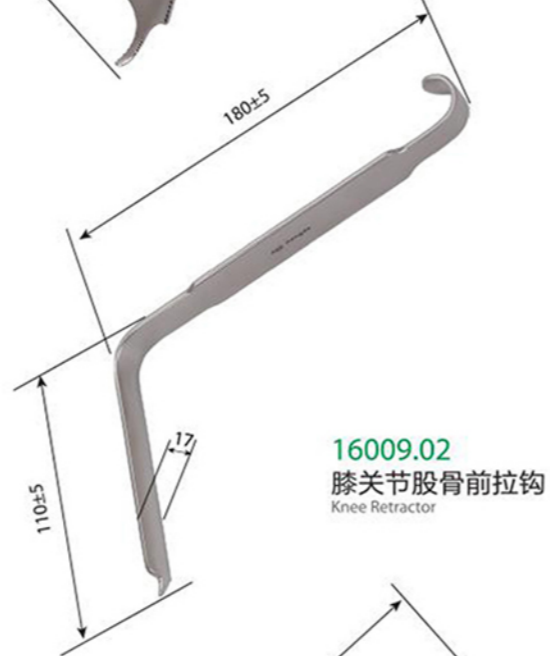

16009.02
膝关节股骨前拉钩
Knee Retractor

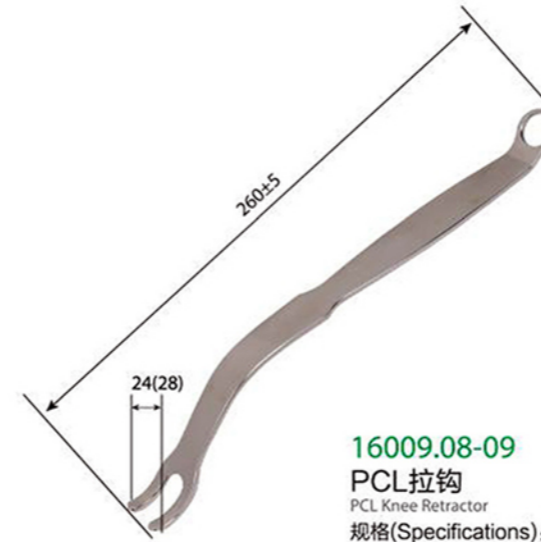

16009.08-09
PCL拉钩
PCL Knee Retractor
规格(Specifications): 大号(Large)、小号(Small)



16009.10
膝关节外侧脂肪垫拉钩
The Knee Fat Pad Retractor



16009.03
膝关节后韧带拉钩
After Knee Ligament Retractor

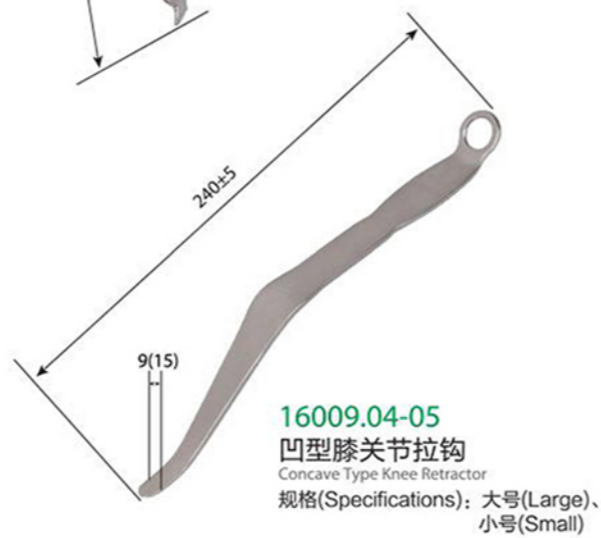

16009.04-05
凹型膝关节拉钩
Concave Type Knee Retractor
规格(Specifications): 大号(Large)、小号(Small)

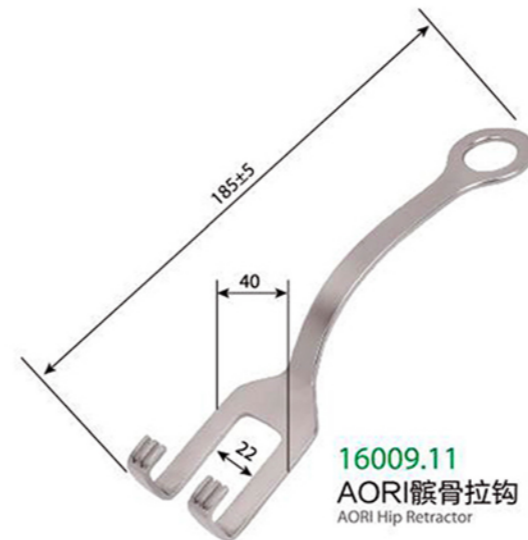

16009.11
AORI髌骨拉钩
AORI Hip Retractor

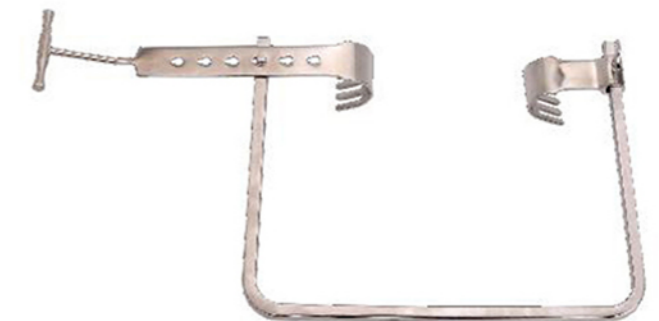

16100.01
髌关节牵开器
Frame Retractor



17007.01-07
新型骨刀
Osteotome
长度(Length): 260mm
刃宽(Blade Width): 6、8、10、12、15、16、18mm



17008.01-07
新型骨刀(镀黑)
Osteotome
长度(Length): 260mm
刃宽(Blade Width): 6、8、10、12、15、16、18mm



17001.01-07
木柄骨刀(直)
Osteotome
长度(Length): 260mm
刃宽(Blade Width): 6、8、10、12、15、16、18mm



17002.01-06
木柄骨刀(加长)
Osteotome
长度(Length): 300mm
刃宽(Blade Width): 6、8、10、12、15、16、18mm



17009.01-05
木柄骨刀(圆凿)
Osteotome
长度(Length): 260mm
刃宽(Blade Width): 6、8、10、12、15mm



17010.01-17
骨刀(薄型六角柄)
Osteotome
长度(Length): 220、260mm
刃宽(Blade Width): 6-30mm



17003.01-06
木柄骨刀(弧形)
Osteotome
长度(Length): 280mm
刃宽(Blade Width): 6、8、10、12、15、18mm



17004.01-03
木柄骨刀(弯曲型)
Osteotome
长度(Length): 260mm
刃宽(Blade Width): 7、11、15mm



17011.01-09
骨刀(新型六角柄)
Osteotome
长度(Length): 260mm
刃宽(Blade Width): 6-30mm



17012.01-09
骨平凿(薄型滚花柄)
Osteotome
长度(Length): 200mm
刃宽(Blade Width): 2、3、4、5、6、8、10、12、15mm



17005.01
木柄骨刀(新型)
Osteotome



17006.01-07
木柄骨刀(镀金)
Osteotome
长度(Length): 260mm
刃宽(Blade Width): 6、8、10、12、15、16、18mm



17013.01-04
骨圆凿(薄型滚花柄)
Osteotome
长度(Length): 200mm
刃宽(Blade Width): 6、8、10、12mm



17014.01-07
硅胶柄骨刀(直)
Osteotome
长度(Length): 260mm
刃宽(Blade Width): 6、8、10、12、15、16、18mm



17015.01-06
硅胶柄骨刀(弧形)
Osteotome
长度(Length): 200mm
刃宽(Blade Width): 6、8、10、12、15、18mm



17016.01-05
硅胶柄骨刀(平刃)
Osteotome
长度(Length): 300mm
刃宽(Blade Width): 6、8、10、12、15mm



17017.01-03
硅胶柄骨刀(弯曲型)
Osteotome
长度(Length): 260mm
刃宽(Blade Width): 7、11、15mm



17018.01-05
硅胶柄骨刀(圆凿)
Osteotome
长度(Length): 260mm
刃宽(Blade Width): 6、8、10、12、15mm



18001.01-63
枪型铝柄骨刮匙(直)
Aluminum Handle Bone Curette
规格(Specification): 2、3、4、5、6、7、8mm
长度(Length): 260mm

枪型铝柄骨刮匙(前弯)
Aluminum Handle Bone Curette
规格(Specification): 2、3、4、5、6、7、8mm
角度(Angle): 16mm × 15°、20°、25°

枪型铝柄骨刮匙(弯)
Aluminum Handle Bone Curette
规格(Specification): 2、3、4、5、6、7、8mm
角度(Angle): 260 × 5°、10°、15°、20°、25°



18002.01-63
木柄骨刮匙(直)
Wooden Handle Bone Curette
规格(Specification): 2、3、4、5、6、7、8mm
长度(Length): 300mm

木柄柄骨刮匙(前弯)
Wooden Handle Bone Curette
规格(Specification): 2、3、4、5、6、7、8mm
角度(Angle): 16mm × 15°、20°、25°

木柄柄骨刮匙(弯)
Wooden Handle Bone Curette
规格(Specification): 2、3、4、5、6、7、8mm
角度(Angle): 300 × 5°、10°、15°、20°、25°



18003.01-63
方型铝柄骨刮匙(直)
Aluminum Handle Bone Curette
规格(Specification): 2、3、4、5、6、7、8mm
长度(Length): 280mm

方型铝柄骨刮匙(弯)
Aluminum Handle Bone Curette
规格(Specification): 2、3、4、5、6、7、8mm
角度(Angle): 280 × 5°、10°、15°、20°、25°

方型铝柄骨刮匙(左/右弯)
Aluminum Handle Bone Curette
方型铝柄骨刮匙(双左/右弯)
Aluminum Handle Bone Curette
规格(Specification): 2、3、4、5、6、7、8mm
长度(Length): 280mm



18004.01-04
带齿骨刮匙
Toothed Curette
规格(Specification): 5、9mm
长度(Length): 300mm



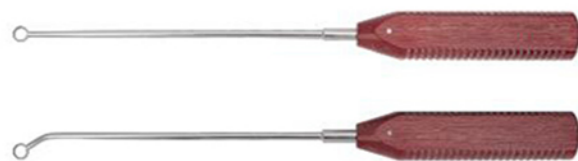

18005.01-03

圆形开口骨刮匙

Bone Curette

规格(Specification): 10mm(直、左弯、右弯)

长度(Length): 410mm



18006.01-03

三角形开口骨刮匙

Bone Curette

规格(Specification): 10mm(直、左弯、右弯)

长度(Length): 390mm



18007.01-02

方头开口骨刮匙

Bone Curette

规格(Specification): 4、5mm

长度(Length): 295mm



18008.01-04

圆头开口骨刮匙

Bone Curette

规格(Specification): 7、8、9、10mm

长度(Length): 295mm



18009.01-03

弯型骨刮匙

Bone Curette

规格(Specification): 3、4、5mm

长度(Length): 350mm



18010.01-12

圆木柄骨刮匙

Bone Curette

规格(Specification): 3、5、7mm

(直、左弯、右弯、后弯)

长度(Length): 335mm



19008.01

多钩牵开器(3×4齿)

Multi Hook Retractor



19008.02

多钩牵开器(5×6齿)

Multi Hook Retractor



19007.01-02

单钩牵开器

Single Hook Retractor

钩深(Hook Deep): 40mm、60mm



19210.01

多钩后颅牵开器(4×4齿)

Postcranial Retractor



19009.01-03

单钩后颅牵开器

Single-hook postcranial Retractors

规格: 大号、中号、小号



19020.01

坐骨神经牵开器I型

Nervilschiadicus Retractors I



19021.01

坐骨神经牵开器II型

Nervilschiadicus Retractors II



19022.01

木柄牵开器

Wooden Handle Retractor



19002.01
床头牵引架
Bedside Traction Rack



19001.01
勃朗氏架
Brownian Stand



20027.01
台式断棒器
Desk Type Rod Breaking Device



台式断棒器配件



20025.01-15
髓腔绞刀
Medullang Reamer
全长(Length): 280mm
规格(Specifications): $\phi 7.0$ 、 $\phi 7.5$ 、 $\phi 8.0$ 、 $\phi 8.5$ 、 $\phi 9.0$ 、 $\phi 9.5$ 、 $\phi 10.0$ 、 $\phi 10.5$ 、 $\phi 11.0$ 、 $\phi 11.5$ 、 $\phi 12.0$ 、 $\phi 12.5$ 、 $\phi 13.0$ 、 $\phi 13.5$ 、 $\phi 14.0$



19004.01
颅骨牵引弓(弧形)
Skull Tractive Bow
规格(Specifications): 大号(Large Size)、小号(Small Size)



19005.01
颅骨牵引弓
Skull Tractive Bow
规格(Specifications): 大号(Large Size)



20028.01
台式钢板折弯器
Table Type Plate Bending Device



20026.01-15
软管绞刀
Tube Reamer
全长(Length): 450mm
规格(Specifications): $\phi 7.0$ 、 $\phi 7.5$ 、 $\phi 8.0$ 、 $\phi 8.5$ 、 $\phi 9.0$ 、 $\phi 9.5$ 、 $\phi 10.0$ 、 $\phi 10.5$ 、 $\phi 11.0$ 、 $\phi 11.5$ 、 $\phi 12.0$ 、 $\phi 12.5$ 、 $\phi 13.0$ 、 $\phi 13.5$ 、 $\phi 14.0$



19006.01-02
颅骨牵引弓
Skull Tractive Bow
规格(Specifications): 中号(Medium Size)、小号(Small Size)



19003.01-03
克氏针牵引架
Kirschner Traction Bow
规格(Specifications): 大号(Large Size)、中号(Medium Size)、小号(Small Size)



20001.01
股骨撑开复位器
Open the Femoral Reset Decide



20002.01
股骨头取出器
Femoral Head Extractor



20003.01-04

木柄骨锤

Hammer

规格(Specifications): 270g、350g、450g、550g



20004.01-04

硅胶柄骨锤

Hammer

规格(Specifications): 270g、350g、450g、550g



20005.01-03

弯型漏斗

Funnel-shaped Bend

规格(Specifications): ϕ 5、 ϕ 6、 ϕ 7



20006.01-03

双室内植骨漏斗

Double Room Funnel Bone Graft

规格(Specifications): ϕ 5、 ϕ 6、 ϕ 7



20007.01-02

骨锉(大号)

Bone File

规格(Specifications): 长(Long)、短(Short)



20007.01-02

骨锉(小号)

Bone File



20020.01-09

木柄钢丝引导器(直、左弯、右弯)

Wooden Hand Wire Guider

规格(Specifications): 大号(Large size)、中号(Medium size)、小号(Small size)



20019.01-09

钢丝引导器(直、左弯、右弯)

Wire Guider

规格(Specifications): 大号(Large size)、中号(Medium size)、小号(Small size)



20015.01

骨撬(面包型)

Bone Elevator



20016.01

骨撬

Bone Elevator



20010.01-06

锤骨器

Hammer Bone

刃宽(Blade Width): 3.5mm、5.0mm、6.5mm

角度(Angle): 90°、110°



20010.07

锤骨器(新型)

Hammer Bone



20031.01

木柄剥离器

Periosteal Elevator



20009.01-04

骨膜分离器

Periosteal Branch Vessels

规格(Specifications): ϕ 15、 ϕ 20

刃口: 钝口(Blunt)、锐口(Sharp)



20012.01-03

骨钩(铝柄)

Bone Hook

规格(Specifications): 大号(Large size)、中号(Medium size)、小号(Small size)



20013.01

骨钩(板材式)

Bone Hook



20014.01-02

骨钩(木柄)

Bone Hook

规格(Specifications): 大号(Large size)、小号(Small size)



20029.01
多功能起子(梅花)
Multifunctional Screwdriver(Star)
梅花规格:
5.3/4.5
2.3/2.3
2.8/3.8
3.1/4.3
3.4/4.3
3mm/5mm 一字

20030.01
多功能起子(六角)
Multifunctional Screwdriver(Hexagonal)
六角规格:
4.0/4.5
3.0/4.0
2.5/2.5
1.5/2.0
3.5/2.4 十字
1.2/ 1.5 四方



20018.01-03
三爪把持器
Three-jaw Bone Holder
规格(Specifications): 大号(Large Size)、
中号(Medium Size)、小号(Small Size)



20024.01
手枪式手摇骨钻
Hand Drill



20023.01-02
显影尺
Developing Rule
规格(Specifications): 200mm、300mm



20017.01-06
骨膜剥离器
Periosteal Elevator
刃口: 平口、圆口
规格(Specifications): 10、15、20mm



20021.01
神经剥离子(3 × 1套)
Nerve Elevator



20022.01-02
神经剥离子(带钩带槽)(带钩带刃)
Nerve Elevator



20101.01
阴道压板
Vaginal Plate



20102.01
宫颈压板
Cervical Plate



20103.01
固有韧带钩型钳
Uterine Hook Tenaculum Forceps



20104.01
子宫剥离器
Myoma Dissector



20105.01
双爪钳
Utility Forceps



20106.01
单爪钳
Uterine Tenaculum Forceps



20107.01-02
缝合器(左、右)
Stitching Instrument(Left- Right)



20108.01
缝合器(枪型)
Stitching Instrument

φ 4.5空心钉安装器械包

Φ4.5 Cannulated Screw Instrument Set

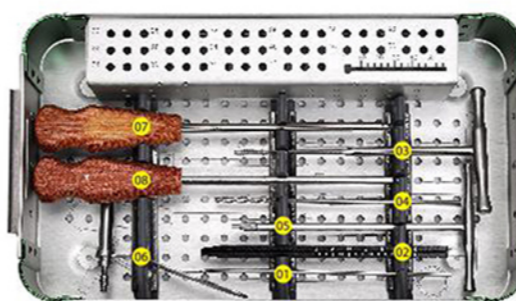

序号 No.	编号 Product No.	产品名称 Item	规格 Size
1	20401.01	螺纹导针 Guide Pin	Φ1.5
2	20402.01	导针测深器 Guide Wire Depth Gauge	
3	20403.01	空心丝锥 Screw Tap	HA4.5
4	20404.01	空心钻头 Dill Cannulated	φ3.2
5	20405.01	空心埋头钻 Countersink Dill, Cannulated	φ6
6	20406.01	多层导钻 Guadrue Drill Guide	Φ1.6×4孔
7	20407.01	内六角起子 Protected Screw Driver	SW2.5
8	20408.01	空心起子 Cannulated Hex Screwdriver	SW2.5
9	20409.01	器械盒 Instruments Box	

φ 4.5空心钉安装器械包

Φ4.5 Cannulated Screw Instrument Set

20401.01

螺纹导针

Guide Pin

规格(Specifications): φ 1.5

20402.01

导针测深器

Guide Wire Depth Gauge

20403.01

空心丝锥

Screw Tap

规格(Specifications): HA4.5

20404.01

空心钻头

Drill Cannulated

规格(Specifications): φ 3.2

20405.01

空心埋头钻

Countersink Drill, Cannulated

规格(Specifications): φ 6

20406.01

多层导钻

Guadruple Drill Guide

规格(Specifications): φ 1.6×4孔

20407.01

内六角起子

Protected Screw Driver

规格(Specifications): SW2.5

20408.01

空心起子

Cannulated Hex Screwdriver

规格(Specifications): SW2.5

φ 7.3空心钉安装器械包

Φ7.3 Cannulated Screw Instrument Set

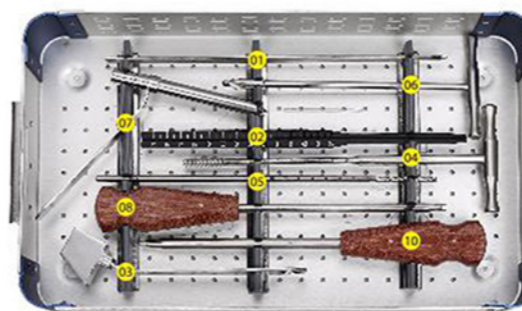
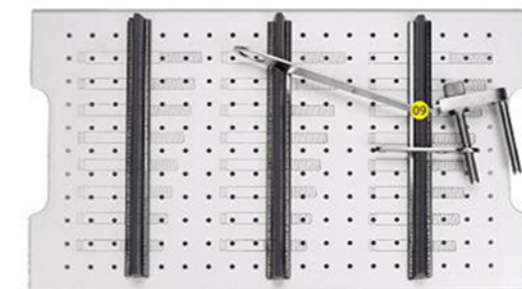

序号 No.	编号 Product No.	产品名称 Item	规格 Size
1	20601.01	螺纹导针 Guide Pin	Φ2.5
2	20602.01	导针测深器 Guide Wire Depth Gauge	Φ2.5
3	20603.01	多孔导向器 Drill Guide	Φ2.6
4	20604.01	空心丝锥 Screw Tap	HB7.3
5	20605.01	空心钻头 Drill Cannulated	Φ4.8
6	20606.01	空心埋头钻 Countersink Drill, Cannulated	Φ8
7	20607.01	多层导钻 Guadruple Drill Guide	Φ2.6×4孔
8	20608.01	空心起子 Cannulated Hex Screwdriver	SW4.0
9	20609.01	平行导向器 Double Hole Drill Guide Wrench	
10	20610.01	内六角起子 Protected Screw Driver	SW4.0
11	20611.01	器械盒 Instruments Box	

Φ7.3空心钉安装器械包

Φ7.3 Cannulated Screw Instrument Set

20601.01

螺纹导针

Guide Pin

规格(Specifications): Φ2.5

20602.01

导针测深器

Guide Wire Depth Gauge

规格(Specifications): Φ2.5

20603.01

多孔导向器

Drill Guide

规格(Specifications): Φ2.6

20604.01

空心丝锥

Screw Tap

规格(Specifications): HB7.3

20605.01

空心钻头

Drill Cannulated

规格(Specifications): Φ4.8

20606.01

空心埋头钻

Countersink Drill, Cannulated

规格(Specifications): Φ8

20607.01

多层导钻

Quadrupe Drill Guide

规格(Specifications): Φ2.6×4孔

20608.01

空心起子

Cannulated Hex Screwdriver

规格(Specifications): SW4.0

20609.01

平行导向器

Double Hole Drill Guide Wrench

20610.01

内六角起子

Protected Screw Driver

规格(Specifications): SW4.0

上肢骨折手术器械包(大套)

Small Fragment Instrument Set(Full)

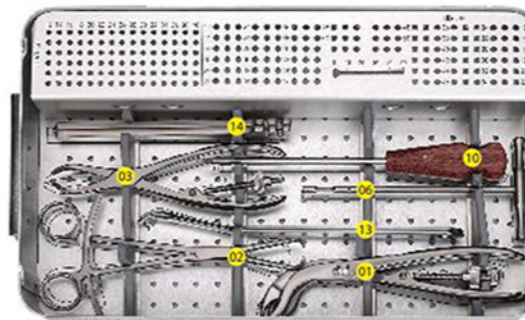

序号 No.	编号 Product No.	产品名称 Item	规格 Size
1	20901.01	自动化中心持骨钳 Self-centering Forceps	全长190mm
2	20902.01	带尖复位钳 Pointed Reduction Forceps	全长150mm
3	20903.01	普通复位钳 Bone Holding Forcep (Small)	全长170mm
4	20904.01	螺钉夹持钳 Screw Holder Forceps	
5	20905.01	测深器 Depth Gauge	
6	20906.01	断钉空心锯 Broken Screw Extractor	Φ6
7	20907.01-02	丝锥 Screw Tap	HA3.5- HB4.0
8	20908.01	螺钉打滑取出器 Screw Anti-skidding Extractor	小号
9	20909.01	埋头钻 Countersink Drill	Φ6
10	20910.01	内六角起子 Protected Screw Driver(Hex)	SW2.5
11	20911.01-02	骨膜剥离器 Periosteal Detacher	9mm、12mm
12	20912.01	两用导钻 Drill Guide	Φ2.5
13	20913.01	牵开器 Retractor	小号
14	20914.01	钢板折弯器 Plate Bending Wrench	2×1套
15	20915.01-02	不锈钢钻头 Drill Bit	Φ2.5、Φ3.0
16	20916.01	双头导钻 Double Head Drill Guide	Φ2.5/Φ3.5
17	20917.01	器械盒 Instruments Box	

上肢骨折手术器械包(大套)

Small Fragment Instrument Set(Full)



20901.01
自动化中心持骨钳
Self-centering Forceps
规格(Specifications): 全长190mm



20902.01
带尖复位钳
Pointed Reduction Forceps
规格(Specifications): 全长150mm

上肢骨折手术器械包(大套)

Small Fragment Instrument Set(Full)



20909.01
埋头钻
Countersink Drill
规格(Specifications): $\Phi 6$



20910.01
内六角起子
Protected Screw Driver(Hex)
规格(Specifications): SW2.5



20903.01
普通复位钳
Bone Holding Forcep (Small)
规格(Specifications): 全长170mm



20904.01
螺钉夹持钳
Screw Holder Forceps



20911.01-02
骨膜剥离器
Periosteal Detacher
规格(Specifications): 9mm、12mm



20912.01
两用导钻
Drill Guide
规格(Specifications): $\Phi 2.5$



20905.01
测深器
Depth Gauge



20906.01
断钉空心锯
Broken Screw Extractor
规格(Specifications): $\Phi 6$



20913.01
牵开器
Retractor
规格(Specifications): 小号



20914.01
钢板折弯器
Plate Bending Wrench
规格(Specifications): 2×1套



20907.01-02
丝锥
Screw Tap
规格(Specifications): HA3.5、HB4.0



20907.01-02
螺钉打滑取出器
Screw Anti-skidding Extractor
规格(Specifications): 小号



20915.01-02
不锈钢钻头
Drill Bit
规格(Specifications): $\Phi 2.5/\Phi 3.0$



20916.01
双头导钻
Double Head Drill Guide
规格(Specifications): $\Phi 2.5/\Phi 3.5$

上肢骨折手术器械包(简易)

Small Fragment Instruments Set(Simple)

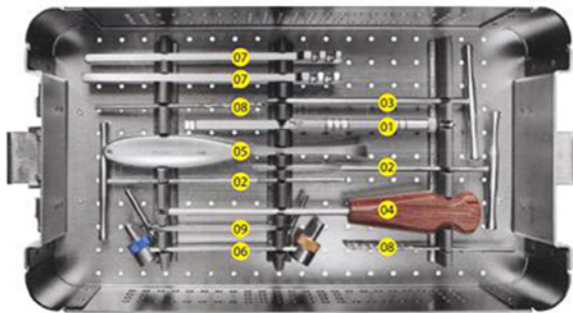
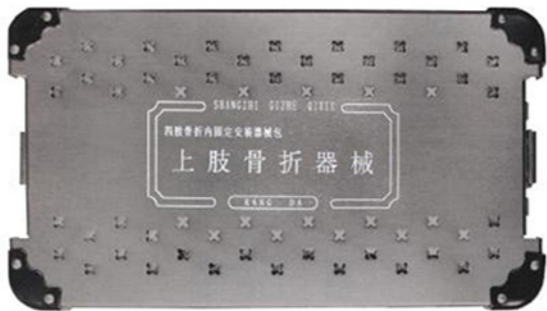

序号 No.	编号 Product No.	产品名称 Item	规格 Size
1	21005.01	测深器 Depth Gauge	60mm
2	21007.01-02	丝锥 Tap	HA3.5、HB4.0
3	21008.01	螺钉打滑取出器 Screw Anti-skidding Extractor	小号
4	21010.01	内六角起子 Protected Screw Driver(Hex)	SW2.5
5	21011.01	骨膜剥离器 Periosteal Detacher	9mm
6	21012.01	两用导钻 Drill Guide	Φ2.5
7	21014.01	钢板折弯器 Plate Bending Wrench	2x1 (套)
8	21015.01-02	不锈钢钻头 Drill Bit	Φ2.5、Φ3.0
9	21016.01	双头导钻 Double Head Drill Guide	Φ2.5/Φ3.0
10	21018.01	器械盒 Instruments Box	

上肢创伤钢板手术工具(大套)

Small Bone Fracture Locking Plate Instrument(Full)

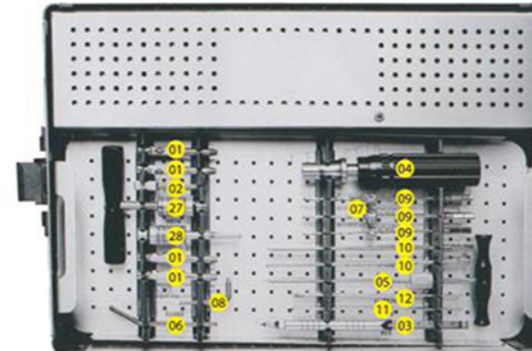
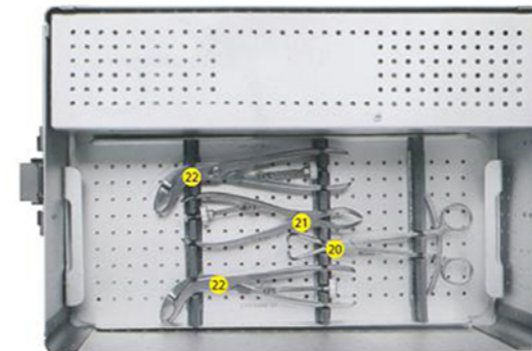

序号 No.	编号 Product No.	产品名称 Item	规格 Size
1	20701.01-02	锁定导向器 Guide	Φ2.0/Φ2.9/Φ3.5、 Φ2.0/Φ3.2/Φ4.0
2	20702.01	钻头导向器 Guide	Φ2.0
3	20703.01	测深器 Depth Gauge	60mm
4	20704.01	扭力手柄 Torque Limited Star Screw Driver	1.5N.m
5	20705.01	提拉钻 T-Drill	Φ3
6	20706.01	钻套扳手 Wrench Bar	
7	20707.01-03	限位器 Drill Stop	Φ2.0、Φ2.9、Φ3.2
8	20708.01	限位器扳手 Wrench of Locking Screw	SW2.5
9	20709.01-03	钻头 Drill Bit	Φ2.0x150、Φ2.9x150、 Φ3.2x150
10	20710.01-02	锁定丝锥 Locking Screw Tap	Φ3.5、Φ4.0
11	20711.01	导针 Pin	Φ2.0x150
12	20712.01	螺纹导针 Guide Pin	Φ2.0x150
13	20713.01	双头导钻 Double Head Drill Guide	Φ2.0
14	20714.01-02	双头导钻 Double Head Drill Guide	Φ2.5/Φ3.5、 Φ3.0/Φ4.0
15	20715.01	两用导钻 Drill Guide	Φ2.5
16	20716.01	双头导钻(自定中心) Drill Guide(Self-centering)	Φ2.5/Φ3.5
17	20717.01	持钉套 Inner Hex Screwdriver Sleeve	
18	20718.01	螺钉夹持器 Screw Holder Forceps	
19	20719.01	钢板折弯器 Plate Bending Wrench	
20	20720.01	带尖复位钳 Small Pointed Reduction Forceps	
21	20721.01	普通复位钳 Bone Holding Forcep(Small)	
22	20722.01	自动中心化持骨钳 Small Self-centering Forceps	全长260mm
23	20723.01-03	快换钻头 Tricorn Bit	Φ2.5x115、Φ3.0x115、 Φ2.0x115
24	20724.01	快换丝锥 Triangular Tap	HA3.5/HB4.0
25	20725.01	埋头钻 Countersink Drill	Φ6
26	20726.01-02	梅花起子 Star Screwdriver	T2.3、T3.4
27	20727.01	T型快换手柄 Quick Change Handle Type T	
28	20728.01	转换接头 Quick Coupling Connector	
29	20729.01	螺钉打滑取出器 Screw Anti-skidding Extractor	
30	20730.01	断钉空心锯 Broken Screw Extractor	Φ6
31	20731.01	六角起子 Protected Screw Driver	SW2.5
32	20732.01	牵开器 Hohmann Retractor	18mm
33	20733.01-02	骨膜剥离器 Periosteum Detacher	9mm、12mm
34	20734.01	器械盒 Instruments Box	

上肢创伤钢板手术工具(简易)

Small Bone Fracture Locking Plate Instrument(Simple)

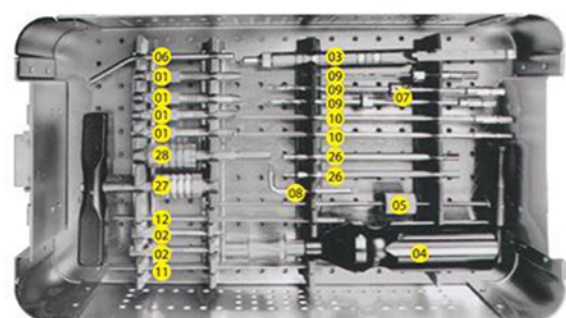

序号 No.	编号 Product No.	产品名称 Item	规格 Size
1	20801.01-02	锁定导向器 Guide	Φ2.0/Φ2.9/Φ3.5、 Φ2.0/Φ3.2/Φ4.0
2	20802.01	钻头导向器 Guide	Φ2.0
3	20803.01	测深器 Depth Gauge	60mm
4	20804.01	扭力手柄 Torque Limited Star Screw Driver	1.5N.m
5	20805.01	提拉钻 T-Drill	
6	20806.01	钻套扳手 Wrench Bar	
7	20807.01-03	限位器 Drill Stop	Φ2.0、Φ2.9、Φ3.2
8	20808.01	限位器扳手 Wrench of Locking Screw	SW2.5
9	20809.01-03	钻头 Drill Bit	Φ2.0×150、Φ2.9×150、 Φ3.2×150
10	20810.01-02	锁定丝锥 Screw Tap	Φ3.5、Φ4.0
11	20811.01	导针 Pin	Φ2.0×150
12	20812.01	螺纹导针 Threaded Guide Pin	Φ2.0×150
13	20826.01-02	梅花起子 Star Screwdriver	T2.3、T3.4
14	20827.01	T型快换手柄 Quick Change Handle Type T	
15	20828.01	转换接头 Quick Coupling Connector	
16	20835.01	器械盒 Instruments Box	

下肢骨折手术器械包(大套)

Large Fragment Instruments Set(Full)

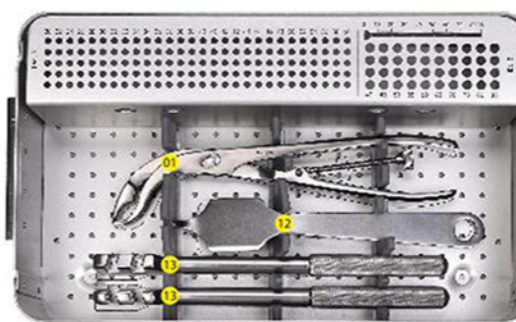
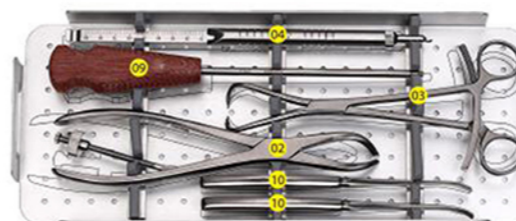

序号 No.	编号 Product No.	产品名称 Item	规格 Size
1	21321.01	自动中心化持骨钳 Self-centering Forceps	全长260mm
2	21322.01	普通复位钳 Reduction Forcep(Large)	全长220mm
3	21323.01	带尖复位钳 Cusp Reduction Forceps(Large)	全长200mm
4	21324.01	测深器 Depth Gauge	90mm
5	21325.01	断钉空心锯 Broken Screw Extractor	Φ8
6	21326.01-02	丝锥 Screw Tap	HA4.5、HB6.5
7	21327.01	螺钉打滑取出器 Screw Anti-skidding Extractor	大号 Large
8	21328.01	埋头钻 Countersink Drill	Φ8
9	21329.01	内六角起子 Protected Screw Driver	SW3.5
10	21330.01-02	骨髓剥离器 Periosteum Detacher	12mm、15mm
11	21331.01	两用导钻 Drill Guide	Φ3.2
12	21332.01	牵开器 Retractor Large	大号 Large
13	21333.01	钢板折弯器 Bone Plate Bender	2×1 (套)
14	21334.01-02	不锈钢钻头 Drill Bit	Φ3.2、Φ4.5
15	21335.01	螺钉夹持钳 Screw-holder Driver	
16	21336.01-02	双头导钻 Double Head Drill Guide	Φ4.5/Φ3.2、Φ4.5/Φ6.5
17	21337.01	器械盒 Instruments Box	

下肢骨折手术器械包(大套)

Large Fragment Instruments Set(Full)



21321.01
自动化中心持骨钳
Self-centering Forceps
规格(Specifications): 全长260mm



21322.01
普通复位钳
Bone Holding Forcep (Small)
规格(Specifications): 全长220mm



21323.01
带尖复位钳
Cusp Reduction Forceps(Large)
规格(Specifications): 全长200mm



21324.01
测深器
Depth Gauge
规格(Specifications): 90mm



21325.01
断钉空心锯
Broken Screw Extractor
规格(Specifications): $\Phi 8$



21326.01-02
丝锥
Screw Tap
规格(Specifications): HA4.5、HB6.5



21327.01
螺钉打滑取出器
Screw Anti-skidding Extractor
规格(Specifications): 大号 Large



21328.01
埋头钻
Countersink Drill
规格(Specifications): $\Phi 8$

下肢骨折手术器械包(大套)

Large Fragment Instruments Set(Full)



21329.01
内六角起子
Protected Screw Driver
规格(Specifications): SW3.5



21330.01-02
骨膜剥离器
Periosteum Detacher
规格(Specifications): 12mm、15mm



21331.01
两用导钻
Drill Guide
规格(Specifications): $\Phi 3.2$



21332.01
牵开器
Retractor Large
规格(Specifications): 大号 Large



21333.01
钢板折弯器
Bone Plate Bender
规格(Specifications): 2×1 (套)



21334.01-02
不锈钢钻头
Drill Bit
规格(Specifications): $\Phi 3.2$ 、 $\Phi 4.5$



21335.01
螺钉夹持钳
Screw-holder Driver



21336.01-02
双头导钻
Double Head Drill Guide
规格(Specifications): $\Phi 4.5/\Phi 3.2$ 、 $\Phi 4.5/\Phi 6.5$

下肢骨折手术器械包(简易)

Large Fragment Instruments Set(Simple)

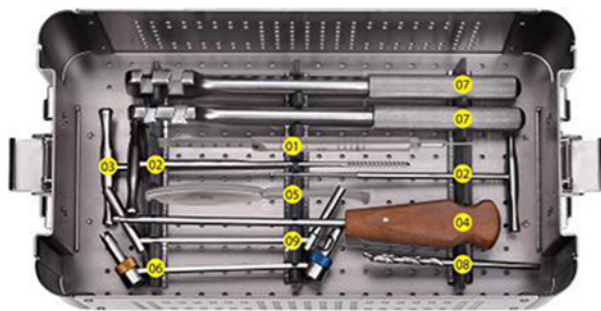
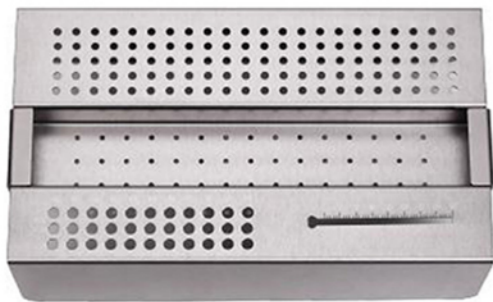

序号 No.	编号 Product No.	产品名称 Item	规格 Size
1	21424.01	测深器 Depth Gauge	90mm
2	21427.01-02	丝锥 Tap	HA4.5、HB6.5
3	21428.01	螺钉打滑取出器 Screw Anti-skidding Extractor	大号 Large
4	21430.01	内六角起子 Protected Screw Driver	SW3.5
5	21431.01	骨膜剥离器 Periosteum Elevator	15mm
6	21432.01	两用导钻 Drill Guide	Φ3.2
7	21434.01	钢板折弯器 Bone Plate Bender	2x1 (套)
8	21435.01-02	不锈钢钻头 Drill Bit	Φ3.2、Φ4.5
9	21436.01-02	双头导钻 Double Head Drill Guide	Φ3.2/Φ4.5、Φ
10	21438.01	器械盒 Instruments Box	4.5/Φ6.5

下肢创伤钢板手术工具

Large Bone Fracture Locking Plate Instrument

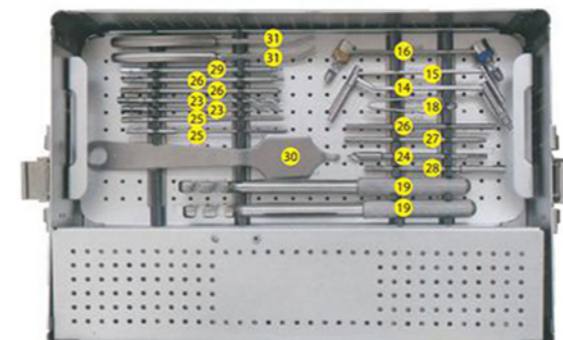
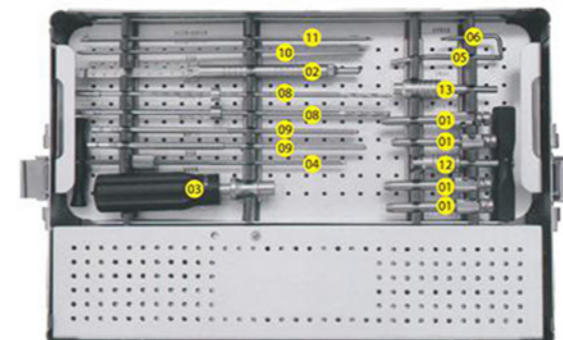
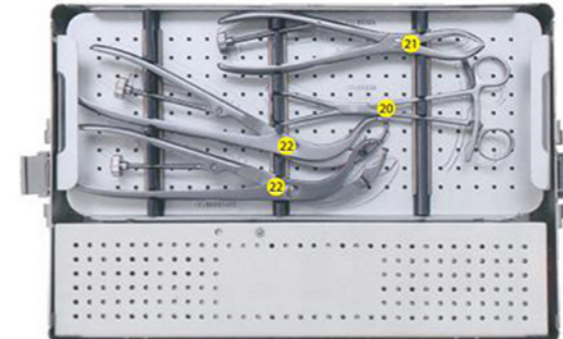

序号 No.	编号 Product No.	产品名称 Item	规格 Size
1	21101.01-02	导向器 Guide	Φ2.0/Φ4.2/Φ5.0、 Φ2.5/Φ5.0/Φ6.5
2	21102.01	测深器 Depth Gauge	90mm
3	21103.01	扭力手柄 Torque Limited Star Screw Driver	4.0N.m
4	21104.01	提拉钻 T-Drill	Φ4
5	21105.01	钻套扳手 Wrench Bar	
6	21106.01	限位器扳手 Wrench of Locking Screw	SW2.5
7	21107.01-02	限位器 Drill Stop	Φ4.2、Φ5.0
8	21108.01-02	钻头 Drill Bit	Φ4.2x280、Φ5.0x280
9	21109.01-02	锁定丝锥(空心) Screw Tap	Φ5.0、Φ6.5
10	21110.01-02	导针 Pin	Φ2.0x250、Φ2.5x250
11	21111.01-02	螺纹导针 Guide Pin	Φ2.0x250、Φ2.5x250
12	21112.01	T型快换手柄 Quick Change Handle Type T	
13	21113.01	转换接头 Quick Coupling Connector	
14	21114.01	双头导钻(自定中心) Drill Guide(Self-centering)	
15	21115.01	双头导钻 Double Head Drill Guide	Φ3.2/Φ6.5
16	21116.01	两用导钻 Drill Guide	Φ3.2
17	21117.01	持钉套 Inner Hex Screwdriver Sleeve	
18	21118.01	螺钉夹持器 Screw Holder	
19	21119.01	钢板折弯器 Bone Plate Bender	
20	21120.01	带尖复位钳 Cusp Reduction Forcep(Large)	
21	21121.01	普通复位钳 Reduction Forcep(Large)	
22	21122.01	自动中心化持骨钳 Self-centering Forceps	全长260mm
23	21123.01-02	快换钻头 Tricorn Bit	Φ3.2x150、Φ4.5x150
24	21124.01	埋头钻 Countersink Drill	Φ8
25	21125.01-02	快换丝锥 Triangular Tap	HA4.5、HB6.5
26	21126.01-03	梅花起子(空心) Star Screwdriver	T4.3、T5.3、T5.3
27	21127.01	螺钉打滑取出器 Screw Anti-skidding Extractor	SW3.5
28	21128.01	断钉空心锥 Broken Screw Extractor	Φ8
29	21129.01	六角起子 Protected Screw Driver	SW3.5
30	21130.01	牵开器 Retractor Large	42mm
31	21131.01-02	骨膜剥离器 Periosteum Detacher	12mm、15mm
32	21132.01	器械盒 Instruments Box	

下肢创伤钢板手术工具(简易)

Large Bone Fracture Locking Plate Instrument(Simple)

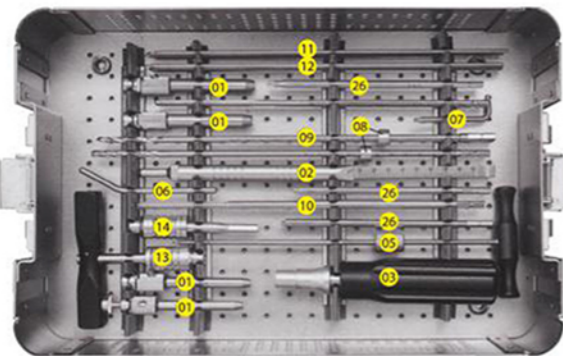
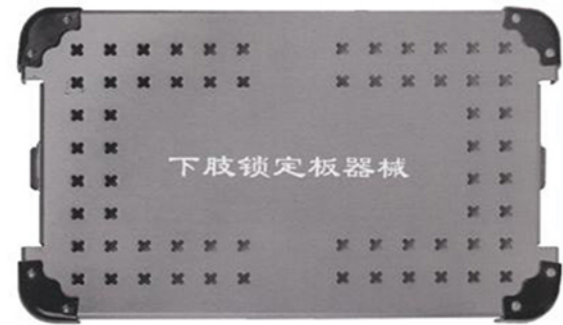

序号 No.	编号 Product No.	产品名称 Item	规格 Size
1	21201.01-02	导向器 Drill Guide	Φ2.0/Φ4.2/Φ5.0、 Φ2.5/Φ5.0/Φ6.5
2	21202.01	测深器 Depth Gauge	90mm
3	21203.01	扭力手柄 Torque Limited Star Screw Driver	4.0N.m
4	21226.01-03	梅花起子(三角快换) Star Screwdriver	T4.3、T5.3、T5.3
5	21205.01	提拉钻(T型) T-Drill	
6	21206.01	钻套扳手 Wrench Bar	
7	21207.01-02	限位器扳手 Wrench of Locking Screw	SW2.5
8	21208.01-02	限位器 Drill Stop	Φ4.2、Φ5.0
9	21209.01-02	钻头 Drill Bit	Φ4.2x280、Φ5.0x280
10	21210.01-02	锁定丝锥 Screw Tap	Φ5.0、Φ6.5
11	21211.01-02	导针 Pin	Φ2.0x250、Φ2.5x250
12	21212.01	螺纹导针 Guide Pin	Φ2.0x250、Φ2.5x250
13	21213.01	T型快换手柄 Quick Change Handle Type T	
14	21214.01	转换接头 Quick Coupling Connector	
15	21233.01	器械盒 Instruments Box	

手指骨折内固定安装器械包

Finger Surgery Instruments Set

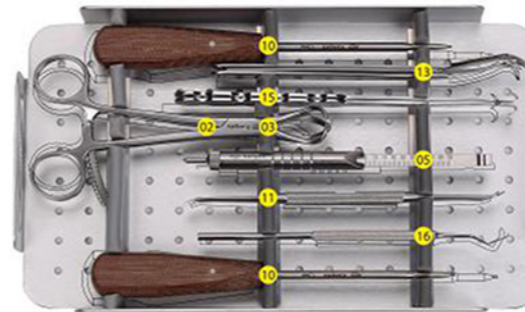
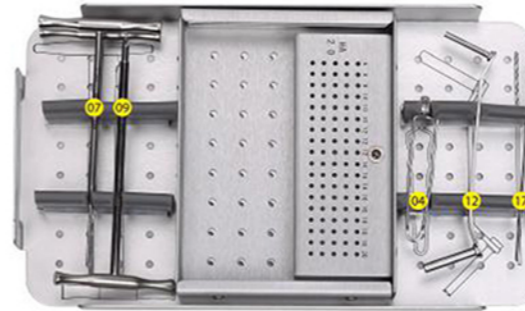
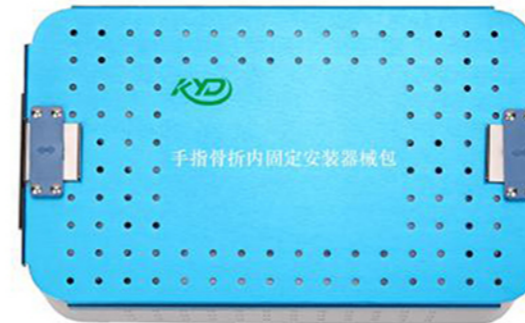

序号 No.	编号 Product No.	产品名称 Item	规格 Size
1	21501.01	双关节咬骨钳 Biaarticular Bonecutting Forceps	刃宽2mm或3mm
2	21502.01	普通复位钳 Curved Reduction Forceps	全长160mm
3	21503.01	带尖复位钳 Cusp Reduction Forceps	全长160mm
4	21504.01	螺钉夹持钳 Screw Holding Forceps	
5	21505.01	测深器 Depth Gauge	50mm
6	21506.01	钢针剪 Wire Cutter	Φ2.5mm
7	21507.01-02	丝锥 Screw Tap	HA2.0、HA2.7
8	21508.01	弯板钳 Plate Bender	
9	21509.01	埋头钻 Countersink Drill	Φ4
10	21510.01	螺钉起子(四方) Screw Driver (Square)	1.2x1.2
11	21511.01-02	双头骨膜剥离器 Periosteum Detacher	大号、小号
12	21512.01	双头导钻 Drill Guide	Φ1.5
13	21513.01-03	牵开器 Periosteal Retractor	大号、中号、小号
14	21514.01	钢板折弯器 Plate Bending Wrench	2x1(套)
15	21515.01	双齿拉钩 Skin Retractor	
16	21516.01	尖端拉钩 Sharp Hook	
17	21517.01	器械盒 Instruments Box	

手指骨折内固定安装器械包

Finger Surgery Instruments Set



21501.01
双关节咬骨钳
Biacicular Bonecutting Forceps
规格(Specifications): 刃宽2mm或3mm



21502.01
普通复位钳
Curved Reduction Forceps
规格(Specifications): 全长160mm



21503.01
带尖复位钳
Cusp Reduction Forceps
规格(Specifications): 全长160mm



21504.01
螺钉夹持钳
Screw Holding Forceps



21505.01
测深器
Depth Gauge
规格(Specifications): 50mm



21506.01
钢针剪
Wire Cutter
规格(Specifications): $\Phi 2.5\text{mm}$



21507.01-02
丝锥
Screw Tap
规格(Specifications): HA2.0、HA2.7



21508.01
弯板钳
Plate Bender

手指骨折内固定安装器械包

Finger Surgery Instruments Set



21509.01
埋头钻
Countersink Drill
规格(Specifications): $\Phi 4$



21510.01
螺钉起子(四方)
Screw Driver (Square)
规格(Specifications): 1.2×1.2



21511.01-02
双头骨膜剥离器
Periosteum Detacher
规格(Specifications): 大号、小号



21512.01
双头导钻
Drill Guide
规格(Specifications): $\Phi 1.5$



21513.01-03
牵开器
Periosteal Retractor
规格(Specifications): 大号、中号、小号



21514.01
钢板折弯器
Plate Bending Wrench
规格(Specifications): 2×1(套)



21515.01
双齿拉钩
Skin Retractor



21516.01
尖端拉钩
Sharp Hook

鹅头钉安装器械包

DHS/DCS Instruments Set

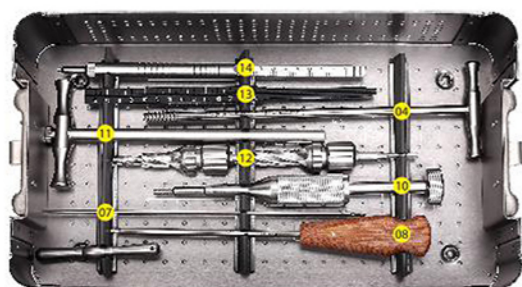
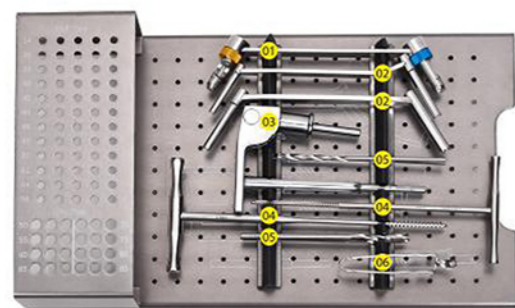
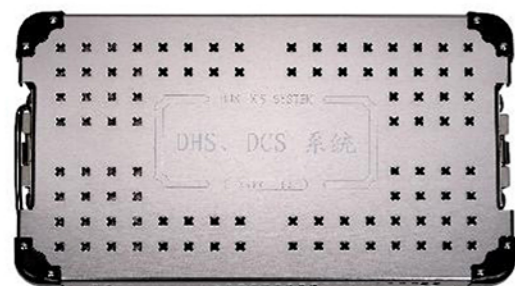

序号 No.	编号 Product No.	产品名称 Item	规格 Size
1	21601.01	两用导钻 Drill Guide	Φ3.2
2	21602.01-02	双头导钻 Double Head Drill Guide	Φ3.2/Φ4.5、Φ4.5/Φ6.5
3	21603.01	角度尺 DHS DCS Adjustable Angle Guide	可调范围90°-180°
3	21603.02	DCS角度尺95° (可选) 95°Driu Guide	
3	21603.03	DHS角度尺135° (可选) 135°Driu Guide	
4	21604.01-02	丝锥 Screw Tap	HA4.5、HB6.5
5	21605.01-02	不锈钢钻头 Drill Bit	Φ3.2、Φ4.5
6	21606.01	螺钉夹持钳 Screw Holding Forceps	
7	21607.01	螺纹导针 Guide Pin	Φ2.5
8	21608.01	内六角起子 Protected Screw Driver	SW3.5
9	21609.01	丝锥 Screw Tap	270mm
10	21610.01	加压器 Compressor	
11	21611.01-02	进退器 Lag Screw Extractor	SW7、SW8
12	21612.01-02	组合铰刀DCS、DHS DCS、DHS Combination Reamer	
13	21613.01	导针测深器 Guide Wire Depth Gauge	
14	21614.01	测深器 Depth Gauge	90mm
15	21615.01	器械盒 Instruments Box	

鹅头钉安装器械包

DHS/DCS Instruments Set



21601.01
两用导钻
Drill Guide
规格(Specifications): Φ3.2



21602.01-02
双头导钻
Double Head Drill Guide
规格(Specifications): Φ3.2/Φ4.5、Φ4.5/Φ6.5



21603.01
角度尺
DHS DCS Adjustable Angle Guide
规格(Specifications): 可调范围90° -180°



21603.02
DCS角度尺95°
95°Driu Guide



21603.03
DHS角度尺135°
135°Driu Guide



21604.01-02
丝锥
Screw Tap
规格(Specifications): HA4.5、HB6.5



21605.01-02
不锈钢钻头
Drill Bit
规格(Specifications): Φ3.2、Φ4.5



21606.01
螺钉夹持钳
Screw Holding Forceps

鹅头钉安装器械包

DHS/DCS Instruments Set

21607.01

螺纹导针

Guide Pin

规格(Specifications): $\Phi 2.5$



21608.01

内六角起子

Protected Screw Driver

规格(Specifications): SW3.5



21609.01

丝锥

Screw Tap

规格(Specifications): 270mm



21610.01

加压器

Compressor



21611.01-02

进退器

Lag Screw Extractor

规格(Specifications): SW7、SW8



21612.01-02

组合铰刀DCS、DHS

DCS、DHS Combination Reamer



21613.01

导针测深器

Guide Wire Depth Gauge



21614.01

测深器

Depth Gauge

规格(Specifications): 90mm



重建钢板手术器械包

Reconstruction Plate Operation Instrument

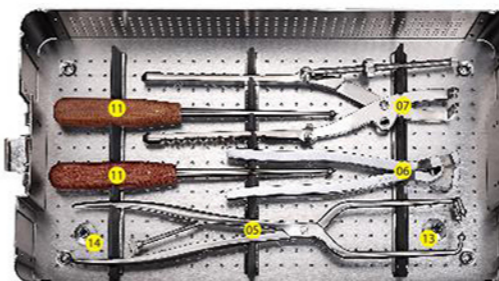
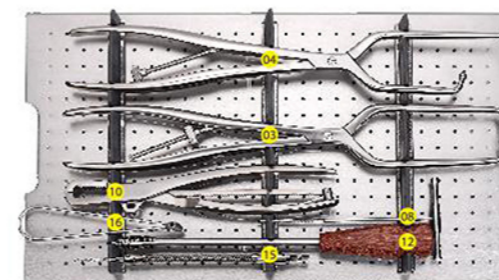
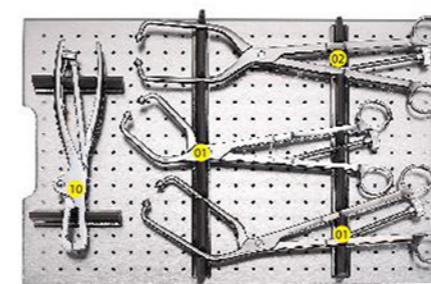
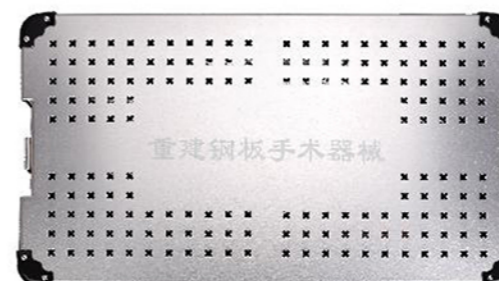

序号 No.	编号 Product No.	产品名称 Item	规格 Size
1	21701.01-02	弯头复位钳 Reduction Forceps	大号、小号 Large, Small
2	21702.01	直头复位钳 Pelvic Reduction Forceps with Points	
3	21703.01	双爪复位钳 Pelvic Reduction Forceps	
4	21704.01	高低双爪复位钳 Pelvic Reduction Forceps	
5	21705.01	三爪复位钳 Pelvic Reduction Forceps with 3Ball Tips	
6	21706.01	双向弯曲钳 Plate Bending Wrench	
7	21707.01	髌臼复位钳 Acetabulum Reduction Forceps	
8	21708.01	丝锥 Screw Tap	HA3.5
9	21709.01	重建钢板折弯器(新型) Plate Bending Wrench	2x1套
10	21710.01-02	多齿持骨钳 Bone Holding Forceps	大号、小号 Large, Small
11	21711.01	顶棒 Loeatingdriver	全长300mm
12	21712.01	万向六角起子 Universal Screw Driver	SW2.5
13	21713.01	带尖活络座(弧形) Ball Tips (Curved)	
14	21714.01	带尖活络座(平形) Ball Tips (Flat)	
15	21715.01	软钻 Drill Guide For Drill Bit	$\Phi 2.5$
16	21716.01	软钻导向器 Sharp Hook	
17	21717.01	器械盒 Instruments Box	

重建钢板手术器械包

Reconstruction Plate Operation Instrument



21701.01-02

弯头复位钳

Reduction Forceps

规格(Specifications): 大号、小号 Large, Small



21702.01

直头复位钳

Pelvic Reduction Forceps with Points



21703.01

双爪复位钳

Pelvic Reduction Forceps



21704.01

高低双爪复位钳

Pelvic Reduction Forceps



21705.01

三爪复位钳

Pelvic Reduction Forceps with 3Ball Tips



21706.01

双向弯曲钳

Plate Bending Wrench



21707.01

髌臼复位钳

Acetabulum Reduction Forceps



21708.01

丝锥

Screw Tap

规格(Specifications): HA3.5

重建钢板手术器械包

Reconstruction Plate Operation Instrument



21709.01

重建钢板折弯器 (新型)

Plate Bending Wrench

规格(Specifications): 2 × 1套



21710.01-02

多齿持骨钳

Bone Holding Forceps

规格(Specifications): 大号、小号 Large, Small



21711.01

顶棒

Loeatingdriver

规格(Specifications): 全长300mm



21712.01

万向六角起子

Universal Screw Driver

规格(Specifications): SW2.5



21713.01

带尖活络座 (弧形)

Ball Tips (Curved)



21714.01

带尖活络座 (平形)

Ball Tips (Flat)



21715.01

软钻

Drill Guide For Drill Bit

规格(Specifications): ϕ 2.5



21716.01

软钻导向器

Sharp Hook

断钉取出器械包

Broken Screw Removal Instrument Set

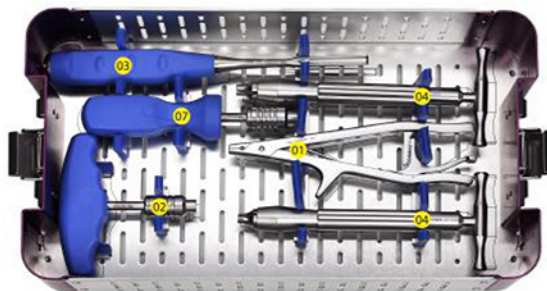
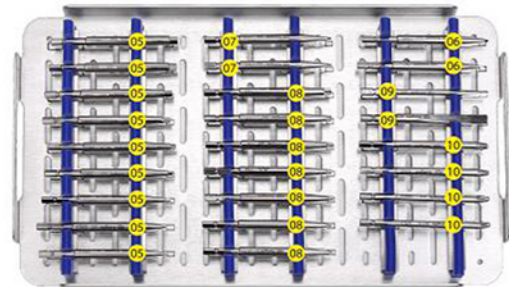
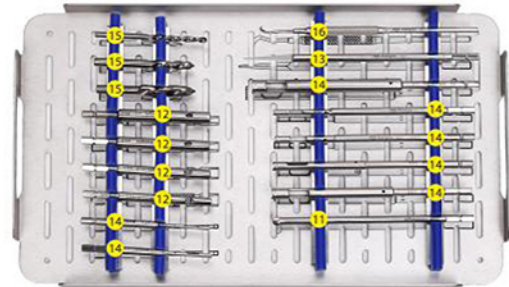

序号 No.	编号 Product No.	产品名称 Item	规格 Size
1	21801.01	断钉取出钳 Forceps for Screw Removal	200mm
2	21802.01	快换手柄T型(硅胶柄) Quick change the handle	
3	21802.02	快换手柄直型(硅胶柄) Quick change the handle	
4	21803.01	骨凿(硅胶柄) The bone chisel (silicone handle)	8mm
5	21804.01-04	断钉取出器 Etraction Bolt	Φ3.5/Φ4.5
6	21805.01-09	六角起子 A.O Hex Head Screwdriver Shaft	SW1.5/SW2.0/SW2.5/SW3.0/SW3.5/ SW4.0/SW4.5/SW5.0/SW5.5
7	21806.01	十字起子手指 Cross screwdriver	小号
8	21807.01-03	四方起子 Cross screwdriver	1.1mm/1.2mm/1.5mm
9	21808.01-07	梅花起子 Star Screwdriver	T2.3/T2.7/T3.2/T3.4/ T3.8/T4.3/T5.3
10	21809.01-02	一字起子(手指) A screwdriver	大号
11	21810.01-04	打滑取出器 Sonical Extraction Screw	SW2.5*0.5/SW2.5/ SW3.5/SW4.0
12	21811.01	脊柱起子固定钉 Spinal screwdriver	
13	21812.01-02	断钉拔出器 Forceps for Screw Removal	Φ3.5/Φ4.5/Φ6.0/Φ6.5
14	21813.01	尖锥 Sharp screwdriver	
15	21814.01-07	断钉空心锯 Broken Screw Extractor	Φ2.7/Φ3/Φ4/Φ5/ Φ6.5/Φ8/Φ10
16	21815.01-03	合金钻头 HSS Drill Bit	Φ4/Φ6/Φ8
17	21816.01	尖钩 Sharp Hook	Φ2.2
18	21817.01	器械盒 Instruments Box	

断钉取出器械包

Broken Screw Removal Instrument Set



21801.01
断钉取出钳
Forceps for Screw Removal
规格(Specifications): 200mm



21802.01
快换手柄T型(硅胶柄)
Quick change the handle



21802.02
快换手柄直型(硅胶柄)
Quick change the handle



21803.01
骨凿(硅胶柄)
The bone chisel (silicone handle)
规格(Specifications): 8mm



21804.01
断钉取出器
Etraction Bolt
规格(Specifications): Φ3.5



21804.02
断钉取出器
Etraction Bolt
规格(Specifications): Φ4.5



21805.01-09
六角起子
A.O Hex Head Screwdriver Shaft
规格(Specifications): SW1.5/ SW2.0/ SW2.5/ SW3.0/ SW3.5/
SW4.0/ SW4.5/ SW5.0/ SW5.5



21806.01
十字起子手指
Cross screwdriver
规格(Specifications): 小号

断钉取出器械包

Broken Screw Removal Instrument Set



21807.01-03

四方起子

Cross screwdriver

规格(Specifications): 1.1mm/1.2mm/1.5mm



21808.01-07

梅花起子

Star Screwdriver

规格(Specifications): T2.3/T2.7/T3.2/T3.4/T3.8/T4.3/T5.3



21809.01-02

一字起子 (手指)

A screwdriver

规格(Specifications): 大号



21810.01-04

打滑取出器

Sonical Extraction Screw

规格(Specifications): SW2.5*0.5/SW2.5/SW3.5/SW4.0



21811.01

脊柱起子固定钉

Spinal screwdriver



21812.01-02

断钉拔出器

Forceps for Screw Removal

规格(Specifications): $\phi 3.5/\phi 4.5/\phi 6.0/\phi 6.5$



21813.01

尖锥

Sharp screwdriver



21814.01-07

断钉空心锯

Broken Screw Extractor

规格(Specifications): $\phi 2.7/\phi 3/\phi 4/\phi 5/\phi 6.5/\phi 8/\phi 10$



21815.01-03

合金钻头

HSS Drill Bit

规格(Specifications): $\phi 4/\phi 6/\phi 8$



21816.01

尖钩

Sharp Hook

脊柱内固定器械包

Spinal System Instruments Set

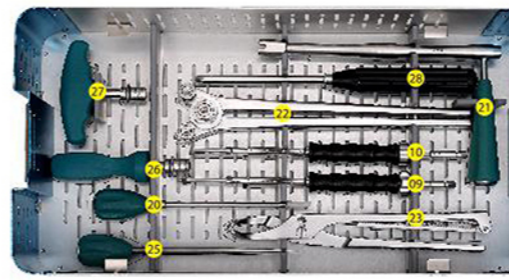
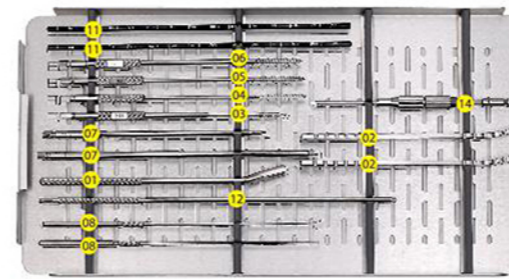
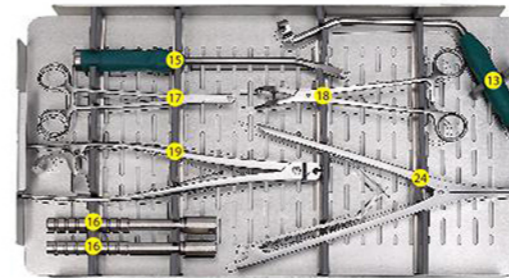

序号 No.	编号 Product No.	产品名称 Item	规格 Size
1	21901.01	折断器 Reduction Screw Tab Breaker	
2	21902.01	转棒器 Double-head Rod Rotation Wrench	
3	21903.01	丝锥 Screw Tap	4.0
4	21904.01	丝锥 Screw Tap	5.0
5	21905.01	丝锥 Screw Tap	5.5
6	21906.01	丝锥 Screw Tap	6.6
7	21907.01-02	梅花起子 Star Screwdriver	T4.5、T5.6
8	21908.01-02	探针 Straight Probe、Curved Probe	直、弯
9	21909.01	固定钉上钉器 Screw Driver For Single-Axial Screw	
10	21910.01	万向钉上钉器 Screw Driver For Multi-Axial Screw	
11	21911.01	模棒 Rod Template	
12	21912.01	螺塞持杆 Screw Holding Rod	
13	21913.01	复位对抗扳手 Reduction Reacting Force Wench	
14	21914.01	限位钻 Stop Limited Drill Boring Driver	
15	21915.01	压棒器 Rocker Clamp	
16	21916.01	撑开套筒 Open Sleeve	
17	21917.01	持棒钳 Rod Rotation Holder Clamp	
18	21918.01	压棒钳 Rocking Forceps	
19	21919.01	转棒钳 Rod Rotation Holder Clamp	
20	21920.01	开口器 Awl	
21	21921.01	抗旋转套筒 Reating Force Wrench	
22	21922.01	弯棒钳 Rod Holder Clamp	
23	21923.01	压缩钳 Curved Hook Compressor	
24	21924.01	撑开钳 Curved Hook Distrator	
25	21925.01	探针 Straight Awd	
26	21926.01	快换手柄 Handle With Quick Coupling	
27	21927.01	T型手柄 T Handle With Quick Coupling	
28	21928.01	显影针植入器 Pedicle Localizer	
29	21929.01	枪式复位钳 Rod Reductor Forceps	
30	21930.01	器械盒 Instruments Box	

脊柱内固定器械包

Spinal System Instruments Set



21901.01
折断器
Reduction Screw Tab Breaker



21902.01
转棒器
Double-head Rod Rotation Wrench



21903.01/21904.01/21905.01/21906.01
丝锥
Screw Tap
规格(Specifications): 4.0/5.0/5.5/6.6



21908.01-02
梅花起子
Star Screwdriver
规格(Specifications): T4.5、T5.6



21909.01
探针
Probe
规格(Specifications): 直(Straight)、弯(Curved)



21910.01
固定钉上钉器
Screw Driver For Single-Axial Screw



21911.01
万向钉上钉器
Screw Driver For Multi-Axial Screw



21912.01
模棒
Rod Template



21913.01
螺塞持杆
Screw Holding Rod



21914.01
复位对抗扳手
Reduction Reacting Force Wench



21915.01
限位钻
Stop Limited Drill Boring Driver



21916.01
压棒器
Rocker Clamp



21917.01
撑开套筒
Open Sleeve



21918.01
持棒钳
Rod Rotation Holder Clamp

脊柱内固定器械包

Spinal System Instruments Set



21919.01
压棒钳
Rocking Forceps



21920.01
转棒钳
Rod Rotation Holder Clamp



21921.01
开口器
Awl



21922.01
抗旋转套筒
Reating Force Wrench



21923.01
弯棒钳
Rod Holder Clamp



21924.01
压缩钳
Curved Hook Compressor



21925.01
撑开钳
Curved Hook Distrator



21926.01
探锥
Straight Awl



21927.01
快换手柄
Handle With Quick Coupling



21928.01
T型手柄
T Handle With Quick Coupling



21929.01
显影针植入器
Pedicel Localizer



21930.01
枪式复位钳
Rod Reductor Forceps

脊柱融合器(多孔型)器械包

Spinal Fusion Device Kit(Multi Pass)

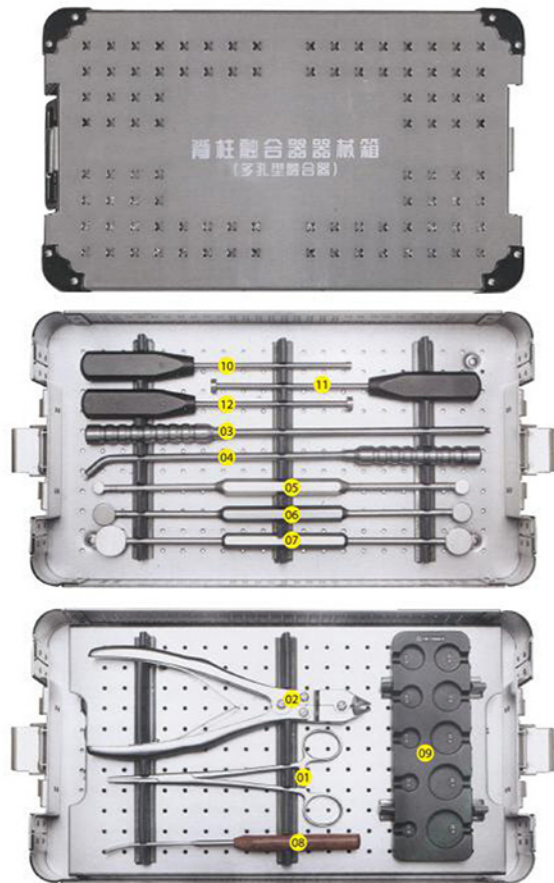

序号 No.	编号 Product No.	产品名称 Item	规格 Size
1	22001.01	植入物夹持器 Mesh Forceps	
2	22002.01	钛笼剪 Titanium Cage Shear	
3	22003.01	辅助推进器(直) Mesh Impactor	直 Straight
4	22004.01	辅助推进器(弯) Mesh Impactor	弯 Angled
5	22005.01	植入物测量器 Implant Measuring Device	Φ10-12
6	22006.01	植入物测量器 Implant Measuring Device	Φ16-18
7	22007.01	植入物测量器 Implant Measuring Device	Φ22-25
8	22008.01	骨锉 Bone file	
9	22009.01	植骨支架 Cage Support	
10	22010.01	压紧器 Squeezer	Φ6
11	22011.01	压紧器 Squeezer	Φ12
12	22012.01	压紧器 Squeezer	Φ18
13	22013.01	器械盒 Instruments Box	



22001.01
植入物夹持器
Mesh Forceps



22002.01
钛笼剪
Titanium Cage Shear



22003.01
辅助推进器
Mesh Impactor
规格(Specifications): 直 Straight



22004.01
辅助推进器
Mesh Impactor
规格(Specifications): 弯 Angled

脊柱融合器(多孔型)器械包

Spinal Fusion Device Kit(Multi Pass)



22005.01
植入物测量器
Implant Measuring Device
规格(Specifications): Φ10-12



22006.01
植入物测量器
Implant Measuring Device
规格(Specifications): Φ16-18



22007.01
植入物测量器
Implant Measuring Device
规格(Specifications): Φ22-25



22008.01
骨锉
Bone file



22009.01
植骨支架
Cage Support
规格(Specifications): Φ3.5



22010.01
压紧器
Squeezer
规格(Specifications): Φ6



22011.01
压紧器
Squeezer
规格(Specifications): Φ12



22012.01
压紧器
Squeezer
规格(Specifications): Φ18

椎间融合器器械包

Vertebral Fusion Device Instrument Kit

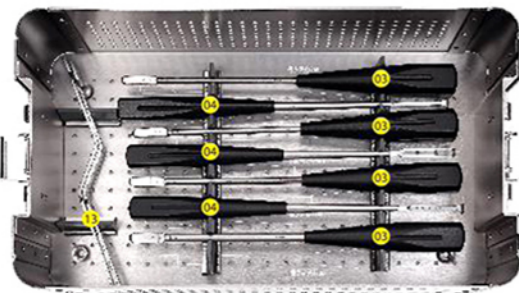
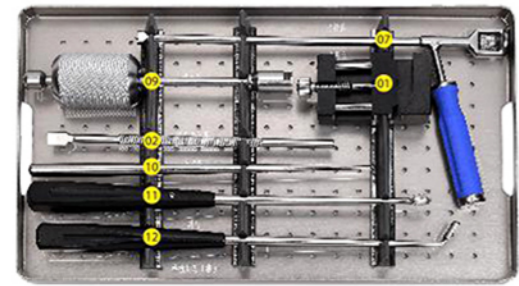
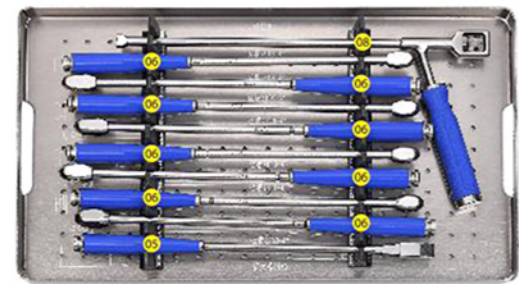

序号 No.	编号 Product No.	产品名称 Item	规格 Size
1	22101.01	植骨台 Bone Grafting TableDouble-head Rod	
2	22102.01	植骨打入器(扁) Bone Grafting Driving In Device(Oblate)	
3	22103.01-04	侧方刮匙 Flank Scraper	9mm、10mm、 11mm、12mm
4	22104.01-03	终板刮匙 Round Scraper	7mm、8mm、9mm
5	22105.01	扩大器 Disc Distractor	24x6
6	22106.01-08	融合器试模 Mold Trial	20x8、20x9、20x10、20x11、 25x9、25x10、25x11、25x12
7	22107.01	腰椎融合器把持器 Threaded Inserter	
8	22108.01	颈椎融合器把持器 Threaded Inserter	
9	22109.01	滑动锤 Slap Hammer	
10	22110.01	植骨器 Graft Impacter	
11	22111.01	带齿刮匙 Push Scraper	
12	22112.01	椎板刮刀 Push Scraper	
13	22113.01-02	神经根拉钩(大、小) Nerve Root Retractor(Large、Small)	
14	22114.01	器械盒 Instruments Box	



椎间融合器器械包

Vertebral Fusion Device Instrument Kit



22101.01
植骨台
Bone Grafting TableDouble-head Rod



22102.01
植骨打入器(扁)
Bone Grafting Driving In Device(Oblate)



22103.01-04
侧方刮匙
Flank Scraper
规格(Specifications): 9mm、10mm、
11mm、12mm



22104.01-03
终板刮匙
Round Scraper
规格(Specifications): 7mm、8mm、9mm



22105.01
扩大器
Disc Distractor
规格(Specifications): 24 x 6



22106.01-04
融合器试模
Mold Trial
规格(Specifications): 25 x 9、25 x 10、
25 x 11、25 x 12



22106.05-08
融合器试模
Mold Trial
规格(Specifications): 20 x 8、20 x 9、
20 x 10、20 x 11



22107.01
腰椎融合器把持器
Threaded Inserter



22108.01
颈椎融合器把持器
Threaded Inserter



22109.01
滑动锤
Slap Hammer



22110.01
植骨器
Graft Impacter



22111.01
带齿刮匙
Push Scraper



22112.01
椎板刮刀
Push Scraper



22113.01
神经根拉钩
Nerve Root Retractor
规格(Specifications): 大 Large



22113.02
神经根拉钩
Nerve Root Retractor
规格(Specifications): 小 Small

颈椎前路钢板安装器械包
Anterior Cervical Plate Mounting Kit

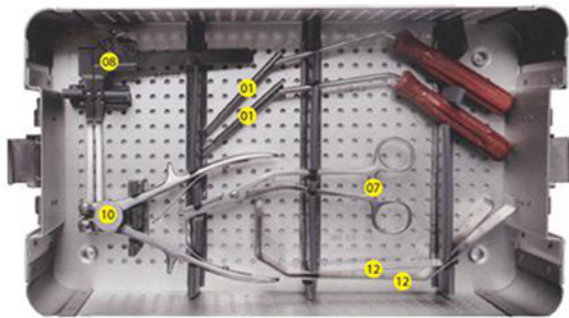
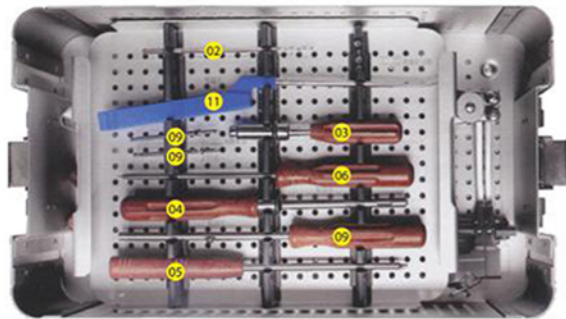

序号 No.	编号 Product No.	产品名称 Item	规格 Size
1	22201.01-02	导钻 Single Head Drill Guide	Φ2.5、Φ3.5
2	22202.01	钻头 Drill Bit	Φ2.5
3	22203.01	快换手柄 Quick Couple Handle	
4	22204.01	颈椎螺钉夹持器 Screw Holder	
5	22205.01	六角改锥 Screwdriver	
6	22206.01	一字改锥 Screwdriver	
7	22207.01	持板钳 Plate Holder	
8	22208.01	颈椎牵开器 Cervical Retractor	
9	22209.01	丝攻螺钉起子 Position Rod Screwdriver	
10	22210.01	弯板钳 Plate Bending Clamp	
11	22211.01	骨刮匙 Bone Curettes	3mm
12	22212.01-02	颈椎拉钩 Cervical Retractor	大号Large、小号Small
13	22213.01	器械盒 Instruments Box	

颈椎前路钢板安装器械包
Anterior Cervical Plate Mounting Kit



22201.01-02
导钻
Single Head Drill Guide
规格(Specifications): Φ2.5、Φ3.5



22202.01
钻头
Drill Bit
规格(Specifications): Φ2.5



22203.01
快换手柄
Quick Couple Handle



22204.01
颈椎螺钉夹持器
Screw Holder



22205.01
六角改锥
Screwdriver



22206.01
一字改锥
Screwdriver



22207.01
持板钳
Plate Holder



22208.01
颈椎牵开器
Cervical Retractor



22209.01
丝攻螺钉起子
Position Rod Screwdriver



22210.01
弯板钳
Plate Bending Clamp



22211.01
骨刮匙
Bone Curettes
规格(Specifications): 3mm



22212.01-02
颈椎拉钩
Cervical Retractor
规格(Specifications): 大号Large、小号Small

颈椎后路钢板安装器械包

Posterior Cervical Plate Instruments Set

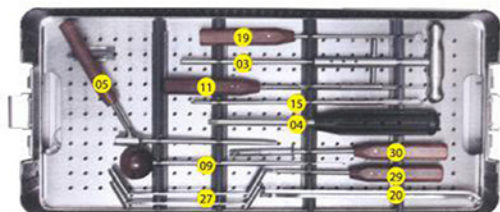
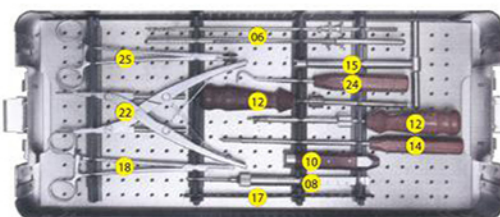
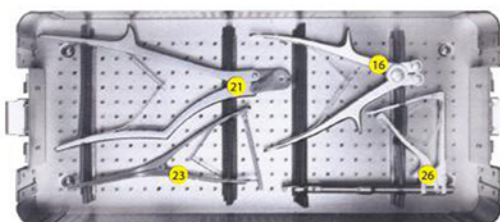

序号 No.	编号 Product No.	产品名称 Item	规格 Size
1	22302.01-02	探针 Curved Probe	直、弯
2	22303.01	开路器 Open Awl	
3	22304.01	显影针植入器 Pedicle Localizer	
4	22305.01	导钻 Guide Drill	
5	22306.01	可调钻头 Drill Bit Cadjustable	Φ2.4
6	22307.01	钻头 Bone File	
7	22308.01	测深器 Depth Gauge	
8	22309.01	探锥 Prick	
9	22310.01	快换手柄 Quick Couple Handle	
10	22311.01	保险丝锥 Screw Tap	
11	22312.01	万向钉上钉器 Screw Driver	
12	22313.01	螺杆菌拾取器 Provisional Plug Driver	
13	22314.01	内六角起子 Protected Star Screw Driver	
14	22315.01	抗旋转扳手 Anti-rotation Spanner	
15	22316.01	弯棒钳 Rod Bending Pliers	
16	22317.01	模棒3.5 Rod Template	
17	22318.01	持棒钳 Rod Holder Forcep	
18	22319.01	推棒器 Push Rod Device	
19	22320.01	弯棒器 Rod Bender (Lift,Right)	
20	22321.01	断棒钳 Rod Cutter	Φ3.5
21	22322.01	平行压缩钳 Compression Clamp	
22	22323.01	撑开钳 Distractor Clamp	
23	22324.01	椎板钩探子 Vertebral Hook Probe	
24	22325.01	持钩钳 Hook Holder Forcep	
25	22326.01	枪式复位钳 Rod Reductor Clamp	
26	22327.01-02	枕骨导向器 Occipital Bone Guide	6/8、10/12
27	22328.01	枕骨钻头 Occipital Bone Drill	
28	22329.01	枕骨丝锥 Occipital Bone Tap	
29	22330.01	多轴螺钉起子 Multi Axis Screw Driver	
30	22331.01	器械盒 Instruments Box	

颈椎后路钢板安装器械包

Posterior Cervical Plate Instruments Set

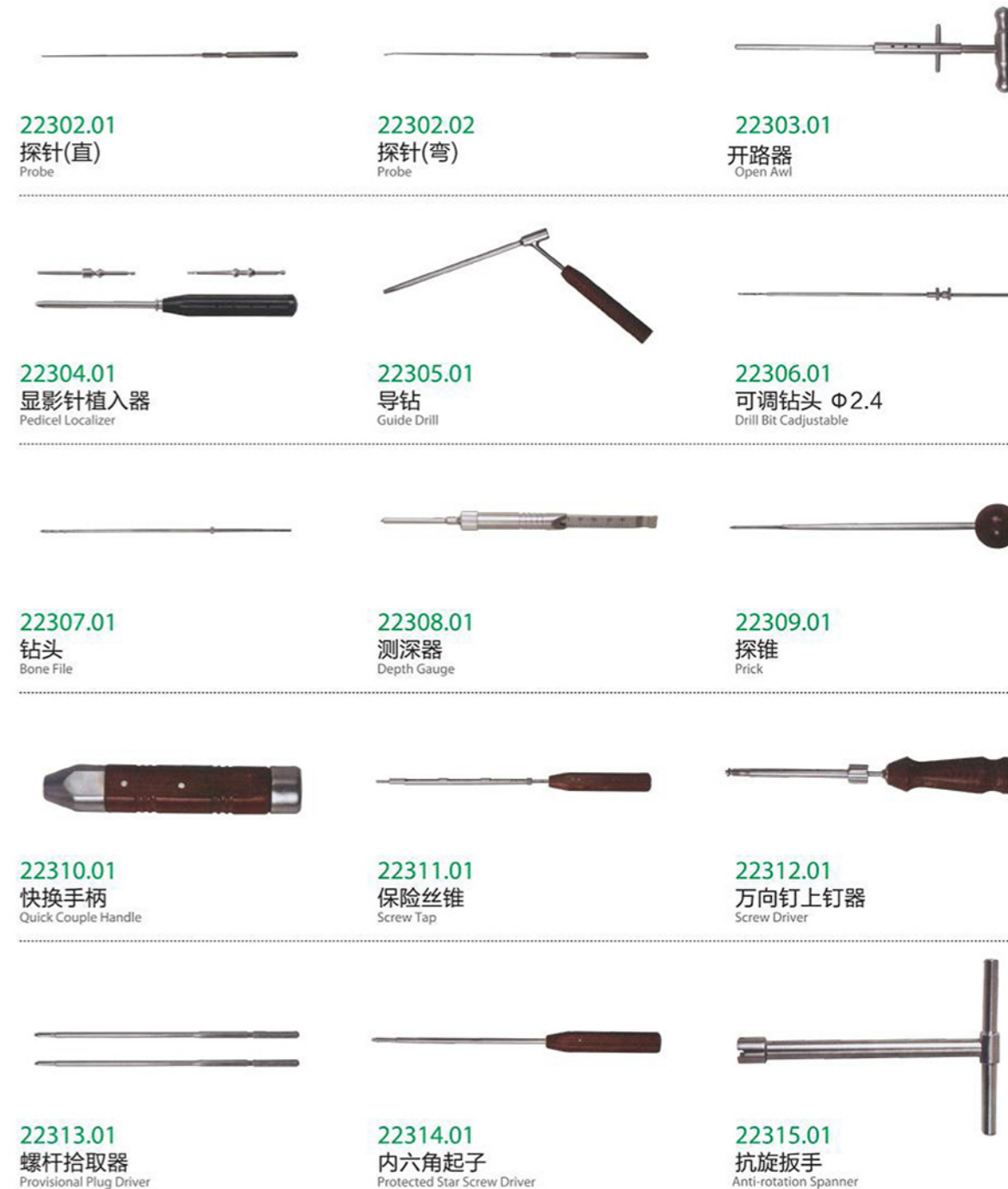

颈椎后路钢板安装器械包

Posterior Cervical Plate Instruments Set



22316.01
弯棒钳
Rod Bending Pliers



22317.01
模棒3.5
Rod Template



22318.01
持棒钳
Rod Holder Forcep



22319.01
推棒器
Push Rod Device



22320.01
弯棒器
Rod Bender (Lift, Right)



22321.01
断棒钳Φ3.5
Rod Cutter



22322.01
平行压缩钳
Compression Clamp



22323.01
撑开钳
Distractor Clamp



22324.01
椎板钩探子
Vertebral Hook Probe



22325.01
持钩钳
Hook Holder Forcep



22326.01
枪式复位钳
Rod Reductor Clamp

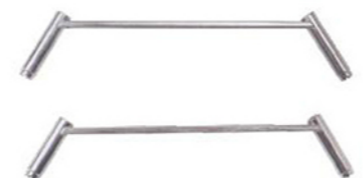

22327.01-02
枕骨导向器6/8、10/12
Occipital Bone Guide



22328.01
枕骨钻头
Occipital Bone Drill



22329.01
枕骨丝锥
Occipital Bone Tap



22330.01
多轴螺钉起子
Multi Axis Screw Driver

肋骨器械包

Encircling Plate Instrument Set

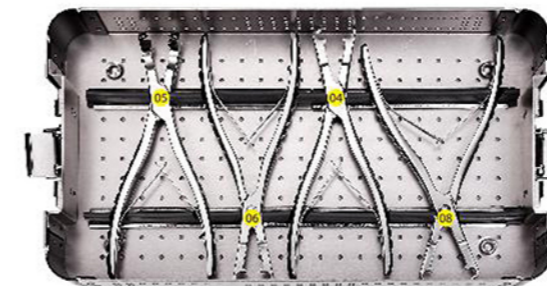
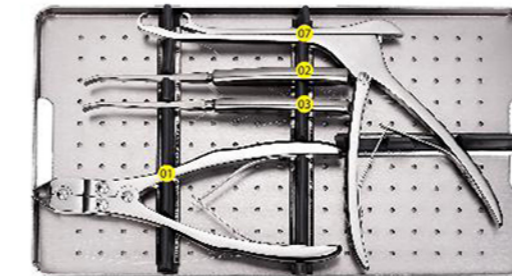
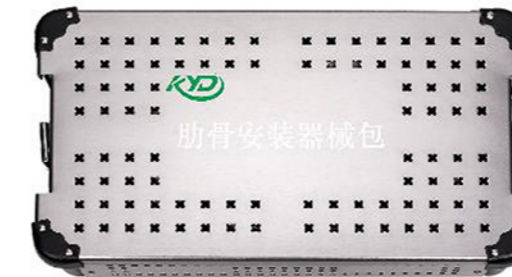

序号 No.	编号 Product No.	产品名称 Item	规格 Size
1	22401.01	肋骨剪断钳 Wire Cutting Forceps	
2	22402.01	骨膜剥离器 Periosteal Elevator	9mm
3	22403.01	骨膜剥离器 Periosteal Elevator	12mm
4	22404.01	肋骨复位钳(直:单) One-Side Compressing Clamp	
5	22405.01	肋骨复位钳(弯) Curved Compressing Clamp	
6	22406.01	肋骨复位钳(直:双) Compressing Clamp	
7	22407.01	肋骨复位钳(枪型) Pillow Compressing Clamp	
8	22408.01	肋骨复位钳(直:双(大)) Compressing Clamp	
9	22409.01	器械盒 Instruments Box	

肋骨器械包

Encircling Plate Instrument Set



22401.01
肋骨剪断钳
Wire Cutting Forceps



22402.01
骨膜剥离器
Periosteal Elevator
规格(Specifications): 9mm



22403.01
骨膜剥离器
Periosteal Elevator
规格(Specifications): 12mm



22404.01
肋骨复位钳 (直: 单)
One-Side Compressing Clamp



22405.01
肋骨复位钳 (弯)
Curved Compressing Clamp



22406.01
肋骨复位钳 (直: 双)
Compressing Clamp



22407.01
肋骨复位钳 (枪型)
Pillow Compressing Clamp



22408.01
肋骨复位钳 (直: 双 (大))
Compressing Clamp

弹性髓内钉安装器械包

Elastic Intramedullary Nail Instrument Set

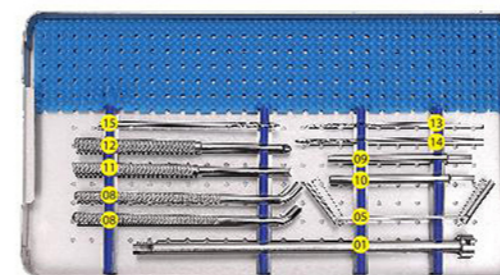

序号 No.	编号 Product No.	产品名称 Item	规格 Size
1	22501.01	滑动杆 Bolt	
2	22502.01	取钉钳 Pincers	
3	22503.01	断棒器 Rod Breaking Device	
4	22504.01	开口器 Gag	
5	22505.01	双头导钻 Double Headed Guide	3.2/4.5
6	22506.01	钻头夹 Drill Chuck	
7	22507.01	骨锤 Bone Hammer	
8	22508.01	折弯器 (2把) Lever	
9	22509.01	打入器 Impactor	大号 Large
10	22510.01	打入器 Impactor	小号 Small
11	22511.01	打入器直口 Impactor	直口
12	22512.01	打入器斜口 Impactor	斜口
13	22513.01	钻头 Bit	Φ2.7
14	22514.01	钻头 Bit	Φ3.2
15	22515.01	钻头 Bit	Φ4.5
16	22515.01	器械盒 Instruments Box	



22501.01
滑动杆
Bolt



22502.01
取钉钳
Pincers

弹性髓内钉安装器械包

Elastic Intramedullary Nail Instrument Set



22503.01
断棒器
Rod Breaking Device



22504.01
开口器
Gag



22505.01
双头导钻
Double Headed Guide
规格(Specifications): 3.2/4.5



22506.01
钻头夹
Drill Chuck



22507.01
骨锤
Bone Hammer



22508.01
折弯器 (2把)
Lever



22509.01 22510.01
打入器
Impactor
规格(Specifications): 大号 Large 小号 Small



22511.01
打入器
Impactor
规格(Specifications): 直口



22512.01
打入器
Impactor
规格(Specifications): 斜口



22513.01 22514.01 22515.01
钻头
Bit
规格(Specifications): $\Phi 2.7$ 、 $\Phi 3.2$ 、 $\Phi 4.5$

椎间盘铰刀器械包

Intervertebral Disc Reamer Instrument Set

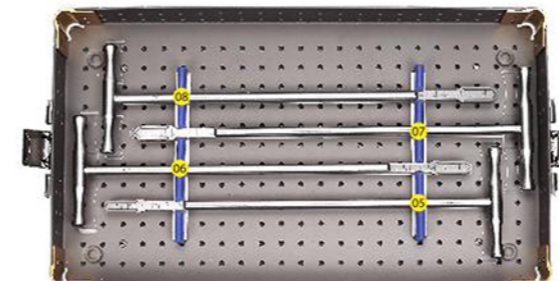
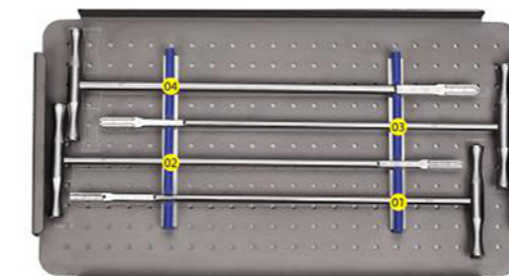
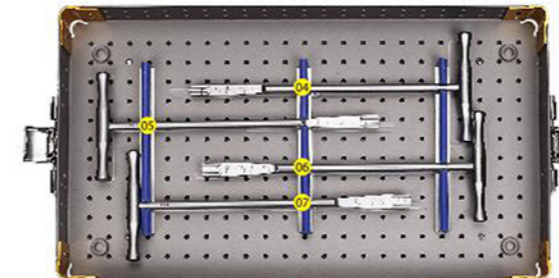
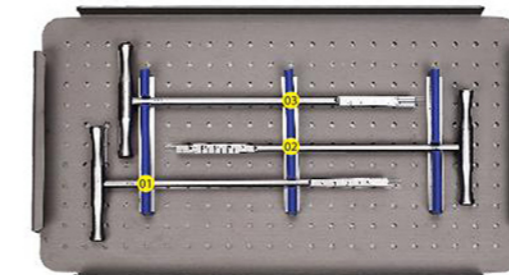

序号 No.	编号 Product No.	产品名称 Item	规格 Size
1	22601.01	椎间盘铰刀 Intervertebral Disc Cutter	$\Phi 6$
2	22601.02	椎间盘铰刀 Intervertebral Disc Cutter	$\Phi 7$
3	22601.03	椎间盘铰刀 Intervertebral Disc Cutter	$\Phi 8$
4	22601.04	椎间盘铰刀 Intervertebral Disc Cutter	$\Phi 9$
5	22601.05	椎间盘铰刀 Intervertebral Disc Cutter	$\Phi 10$
6	22601.06	椎间盘铰刀 Intervertebral Disc Cutter	$\Phi 11$
7	22601.07	椎间盘铰刀 Intervertebral Disc Cutter	$\Phi 12$
8	22601.08	椎间盘铰刀(可选) Intervertebral Disc Cutter	$\Phi 13$
9	22602.01	器械盒 Instruments Box	

序号 No.	编号 Product No.	产品名称 Item	规格 Size
1	22611.01	椎间盘铰刀 Intervertebral Disc Cutter	$\Phi 6$
2	22611.02	椎间盘铰刀 Intervertebral Disc Cutter	$\Phi 7$
3	22611.03	椎间盘铰刀 Intervertebral Disc Cutter	$\Phi 8$
4	22611.04	椎间盘铰刀 Intervertebral Disc Cutter	$\Phi 9$
5	22611.05	椎间盘铰刀 Intervertebral Disc Cutter	$\Phi 10$
6	22611.06	椎间盘铰刀 Intervertebral Disc Cutter	$\Phi 11$
7	22611.07	椎间盘铰刀 Intervertebral Disc Cutter	$\Phi 12$
8	22611.08	椎间盘铰刀 Intervertebral Disc Cutter	$\Phi 13$
9	22612.01	器械盒 Instruments Box	

椎间盘绞刀

Intervertebral Disc Cutter



颈椎前路专用手术器械包

Anterior Cervical Surgical Instruments Set

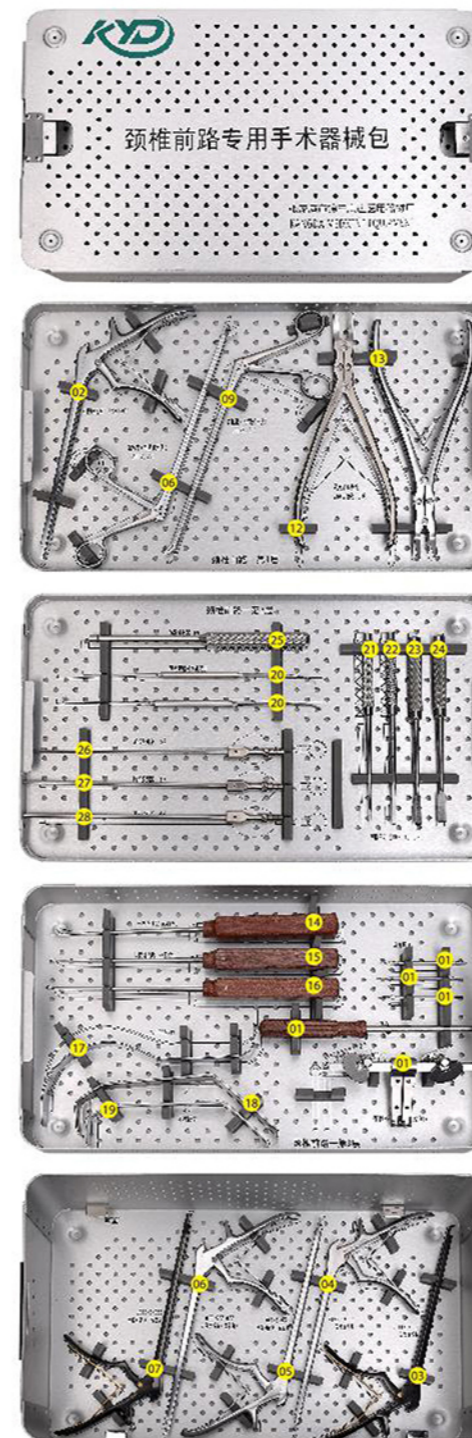

序号 No.	编号 Product No.	产品名称 Item	规格 Size
1	22701.01	颈椎牵开器含牵开器、牵开螺钉及上钉器 Cervical retractor Punch+open screw	
2	22702.01	椎板咬骨钳 Laminectomy Punches	220*1.0*90°
3	22703.01	椎板咬骨钳 Laminectomy Punches	220*2.0*110°
4	22704.01	椎板咬骨钳 Laminectomy Punches	220*2.5*130°
5	22705.01	超薄型椎板咬骨钳 Laminectomy Punches(ultra-thin)	220*1.0*110°
6	22706.01	超薄型椎板咬骨钳 Laminectomy Punches(ultra-thin)	220*2.0*130°
7	22707.01	超薄型椎板咬骨钳 Laminectomy Punches(ultra-thin)	220*2.5*110°
8	22708.01	指圈式髓核钳 Spurling Rongeurs	220*2直头
9	22709.01	指圈式髓核钳 Spurling Rongeurs	220*2弯头
10	22710.01	指圈式髓核钳 Spurling Rongeurs	220*2.5直头
11	22711.01	指圈式髓核钳 Spurling Rongeurs	220*2.5弯头
12	22712.01	双关节咬骨钳 Double Action Bone Rongeurs	240*2微弯
13	22713.01	双关节咬骨钳 Double Action Bone Rongeurs	240*2尖弯
14	22714.01	胶木柄骨刮匙 Bakelite handle Bone Curette	300*3前弯5°
15	22715.01	胶木柄骨刮匙 Bakelite handle Bone Curette	300*3前弯10°
16	22716.01	胶木柄骨刮匙 Bakelite handle Bone Curette	300*4前弯5°
17	22717.01	颈椎S型拉钩(2个) Nerve Retractor(S Clamp)	
18	22718.01	颈椎拉钩大号 Nerve Retractor	
19	22719.01	颈椎拉钩小号 Nerve Retractor	
20	22720.01	神经剥离子带钩带槽 Nerve Elevator	
21	22721.01	滚花柄骨刀 Bone Osteotome,Plain End	200*3
22	22722.01	滚花柄骨刀 Bone Osteotome,Plain End	200*4
23	22723.01	滚花柄骨刀 Bone Osteotome,Plain End	200*5
24	22724.01	滚花柄骨刀 Bone Osteotome,Plain End	200*8
25	22725.01	锤骨器 Hammer bone	Φ8
26	22726.01	加长吸引头 Longer attract head	Φ2
27	22727.01	加长吸引头 Longer attract head	Φ3
28	22728.01	加长吸引头 Longer attract head	Φ4
29	22729.01	器械盒 Instruments Box	

颈椎后路专用手术器械包

Posterior Cervical Surgical Instruments Set

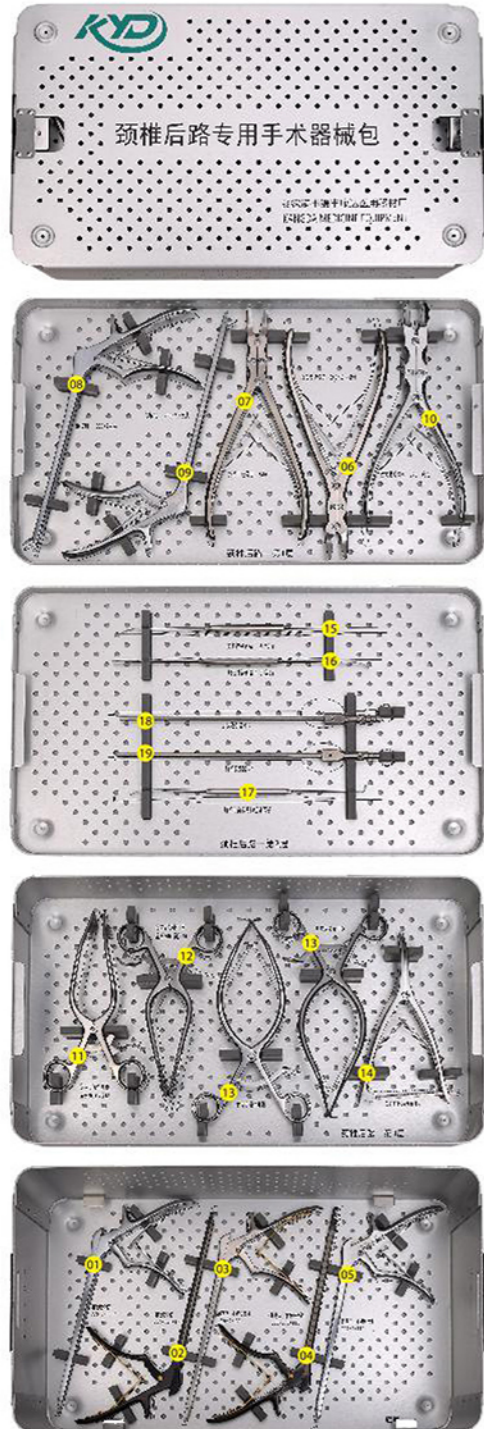

序号 No.	编号 Product No.	产品名称 Item	规格 Size
1	22801.01	椎板咬骨钳 Laminectomy Punches	220*2.0*110°
2	22802.01	椎板咬骨钳 Laminectomy Punches	220*2.5*130°
3	22803.01	超薄型椎板咬骨钳 Laminectomy Punches(ultra-thin)	220*2.0*130°
4	22804.01	超薄型椎板咬骨钳 Laminectomy Punches(ultra-thin)	220*2.5*110°
5	22805.01	超薄型椎板咬骨钳 Laminectomy Punches(ultra-thin)	220*1.0*110°
6	22806.01	双关节咬骨钳 Double Action Bone Rongeurs	240尖形微弯
7	22807.01	双关节咬骨钳 Double Action Bone Rongeurs	240*2微弯
8	22808.01	髓核钳 Laminectomy Rongeurs	220*2直
9	22809.01	髓核钳 Laminectomy Rongeurs	220*2.5直
10	22810.01	双关节咬骨剪 Double Joint Scissors	240弯头
11	22811.01	多钩后颅骨牵开器 Restrctor Self-Retaining Ratchet Type	220*18
12	22812.01	多钩后颅骨牵开器 Restrctor Self-Retaining Ratchet Type	220*30
13	22813.01	单钩后颅骨牵开器 (2把) Single-hook Postcranial Retractors	
14	22814.01	颈椎椎体后缘撑开器 Cervical vertebral rear open	
15	22815.01	神经剥离子 Nerve Elevator	3mm
16	22816.01	神经剥离子 Nerve Elevator	5mm
17	22817.01	神经剥离子带钩带槽 Nerve Elevator	带钩带槽
18	22818.01	加长吸引头 Longer attract head	Φ3
19	22819.01	加长吸引头 Longer attract head	Φ4
20	22820.01	器械盒 Instruments Box	

颈椎前路专用手术器械

Anterior Cervical Surgical Instruments



22701.01
颈椎牵开器含牵开器、牵开螺钉及上钉器
Cervical retractor Punch+open screw



22725.01
锤骨器
Hammer bone
规格(Specifications): Φ8



22726.01 22726.01 22726.01
加长吸引头
Longer attract head
规格(Specifications): Φ2、Φ3、Φ4

颈椎后路专用手术器械

Posterior Cervical Surgical Instruments



22814.01
颈椎椎体后缘撑开器
Cervical vertebral rear open



22818.01 22819.01
加长吸引头
Longer attract head
规格(Specifications): Φ3、Φ4

脊椎后路专用手术器械包(一)
Posterior Spinal Surgical Instruments Set

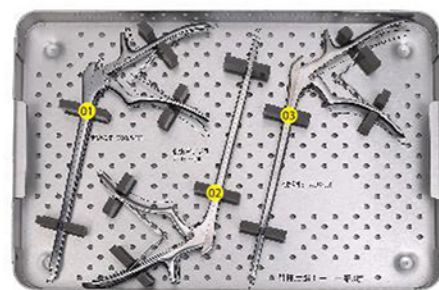
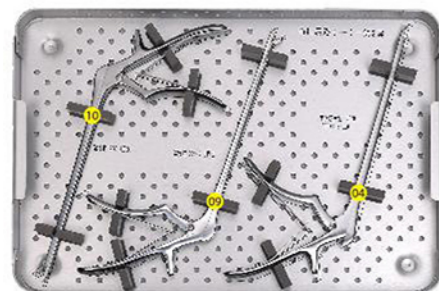
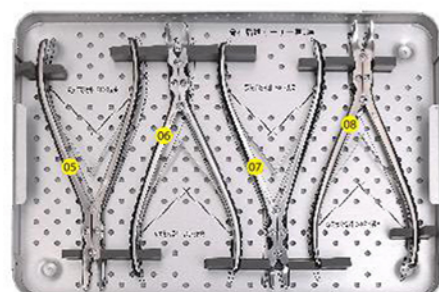

序号 No.	编号 Product No.	产品名称 Item	规格 Size
1	22901.01	椎板咬骨钳 Laminectomy Punches	220*3.5*110°
2	22902.01	椎板咬骨钳 Laminectomy Punches	220*4.0*110°
3	22903.01	超薄型椎板咬骨钳 Laminectomy Punches(ultra-thin)	220*3.5*130°
4	22904.01	超薄型椎板咬骨钳 Laminectomy Punches(ultra-thin)	220*4.5*110°
5	22905.01	双关节咬骨钳 Double Action Bone Rongeurs	240*3直
6	22906.01	双关节咬骨钳 Double Action Bone Rongeurs	240*3微弯
7	22907.01	双关节咬骨钳 Double Action Bone Rongeurs	240*4尖弯
8	22908.01	双关节咬骨钳 Double Action Bone Rongeurs	240尖头微弯
9	22909.01	髓核钳 Laminectomy Rongeurs	220*2.5直头
10	22910.01	髓核钳 Laminectomy Rongeurs	220*3直头
11	22911.01	棘突双关节咬骨钳 Double Joint Outrigger Scissors	直头
12	22912.01	棘突双关节咬骨钳 Double Joint Outrigger Scissors	弯头
13	22913.01	手摇式牵开器 Manual retractor	沟深75mm
14	22914.01	手摇式牵开器 Manual retractor	沟深85mm
15	22915.01	器械盒 Instruments Box	

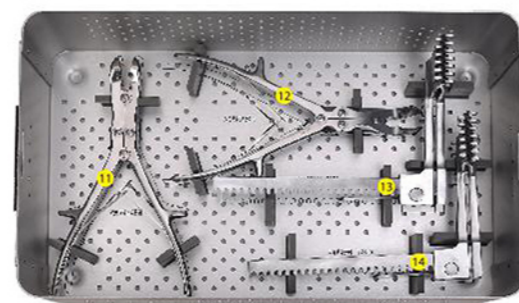

脊椎后路专用手术器械包(二)
Posterior Spinal Surgical Instruments Set

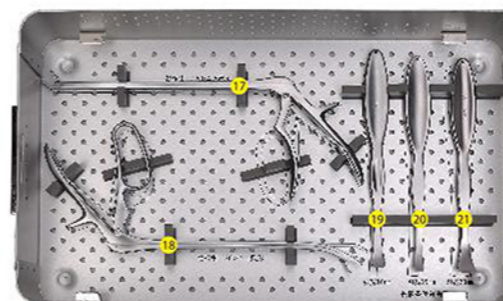
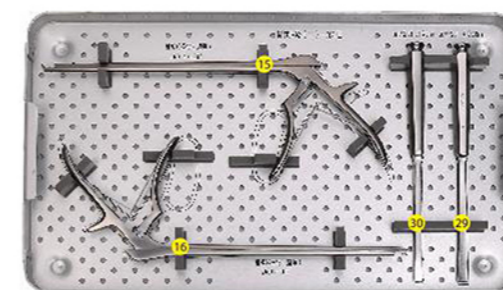

序号 No.	编号 Product No.	产品名称 Item	规格 Size
1	22915.01	椎板咬骨钳 Laminectomy Punches	260*4.0*130°
2	22916.01	超薄型椎板咬骨钳 Laminectomy Punches(ultra-thin)	260*4.0*110°
3	22917.01	髓核钳 Laminectomy Rongeurs	260*4.5弯头
4	22918.01	髓核钳 Laminectomy Rongeurs	260*4.5弧形
5	22919.01	长柄骨髓剥离器 Long handle periosteal stripping device	10mm
6	22920.01	长柄骨髓剥离器 Long handle periosteal stripping device	15mm
7	22921.01	长柄骨髓剥离器 Long handle periosteal stripping device	20mm
8	22922.01	骨髓剥离器 Periosteum Detacher	锐口
9	22923.01	骨髓剥离器 Periosteum Detacher	钝口
10	22924.01	胶木柄骨刮匙 Bakelite handle Bone Curette	300*4直
11	22925.01	胶木柄骨刮匙 Bakelite handle Bone Curette	300*4前弯5°
12	22926.01	胶木柄骨刮匙 Bakelite handle Bone Curette	300*5前弯5°
13	22927.01	胶木柄骨刮匙 Bakelite handle Bone Curette	300*5前弯10°
14	22928.01	六角柄骨刀 Bone Osteotome,Plain End	240*8
15	22929.01	六角柄骨刀 Bone Osteotome,Plain End	240*12
16	22930.01	胶木柄骨刀 New Bone Osteotome	300*10
17	22931.01	器械盒 Instruments Box	

椎间盘切除专用手术器械

Intervertebral Disc Surgical Instruments Set

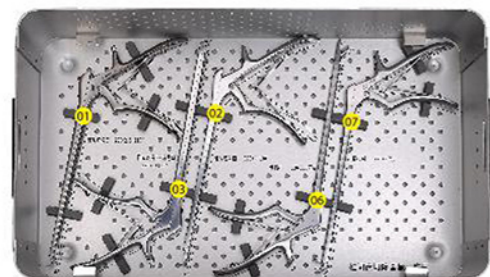
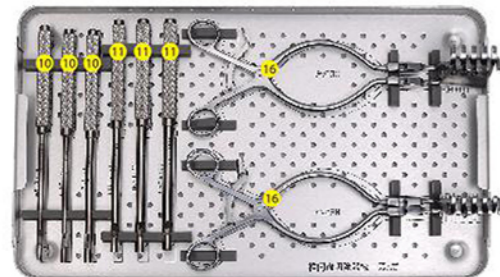
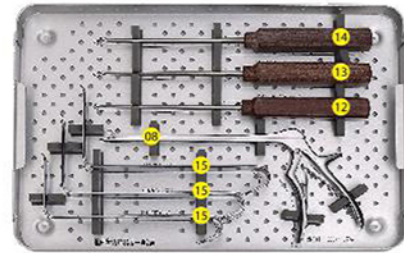
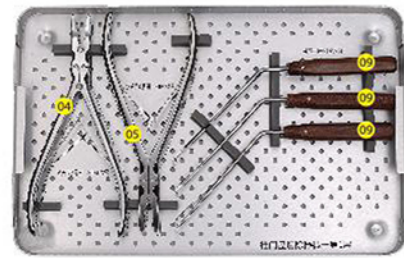

序号 No.	编号 Product No.	产品名称 Item	规格 Size
1	23001.01	椎板咬骨钳 Laminectomy Punches	220*2.5*110°
2	23002.01	椎板咬骨钳 Laminectomy Punches	220*4.0*130°
3	23003.01	超薄型椎板咬骨钳 Laminectomy Punches(ultra-thin)	220*3.0*130°
4	23004.01	双关节咬骨钳 Double Action Bone Rongeurs	240*3微弯
5	23005.01	双关节咬骨钳 Double Action Bone Rongeurs	240*4微弯
6	23006.01	髓核钳 Laminectomy Rongeurs	220*2.5直头
7	23007.01	髓核钳 Laminectomy Rongeurs	220*3弯头
8	23008.01	髓核钳 Laminectomy Rongeurs	220*4.5直头
9	23009.01	胶木柄神经根拉钩 Bakelite Handle Nerve Retractor	135° (3*1)
10	23010.01-03	圆形骨刀 Circular osteotome	Φ6/Φ8/Φ10
11	23011.01-03	椭圆骨刀 The elliptical osteotome	6.5*4.5/8.5*6.5/10.5*8.5
12	23012.01	胶木柄骨刮匙 Bakelite handle Bone Curette	300*4前弯5°
13	23013.01	胶木柄骨刮匙 Bakelite handle Bone Curette	300*5前弯10°
14	23014.01	胶木柄骨刮匙 Bakelite handle Bone Curette	300*6前弯10°
15	23015.01-03	颈椎拉钩 Nerve Retractor	大号/中号/小号
16	23016.01	多钩牵开器 More hook retractor	沟深60mm
17	23017.01	器械盒 Instruments Box	



23010.01-03

圆形骨刀

Circular osteotome

规格(Specifications): Φ6/Φ8/Φ10



23011.01-03

椭圆骨刀

The elliptical osteotome

规格(Specifications): 6.5*4.5/8.5*6.5/10.5*8.5

踝关节器械包

Ankle Instrument Set

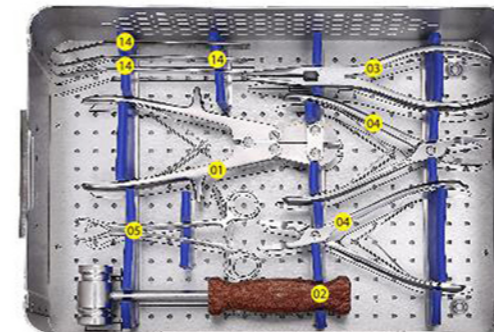
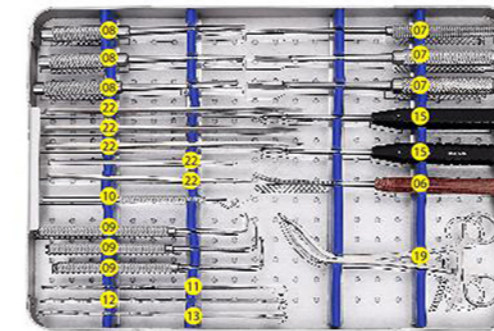
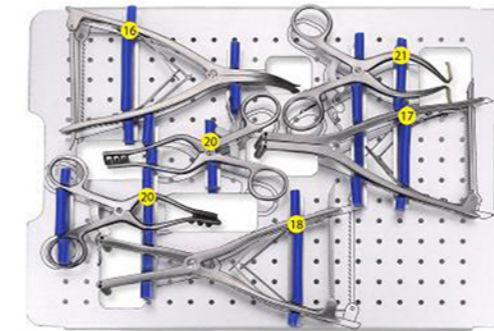

序号 No.	编号 Product No.	产品名称 Item	规格 Size
1	23101.01	小力剪 Small Shear Force	
2	23102.01	骨锤 Bone Hammer With Wood Handle	350克
3	23103.01	尖嘴钳 Sharp-crested Clipper	
4	23104.01-02	单关节咬骨钳 Single-Joint Bone Pliers	180*2直/180*2弯
5	23105.01	带尖复位钳 Cusp Reduction Forceps	
6	23106.01	骨锉 Bone File	小号
7	23107.01-03	骨刀(滚花柄) Bone Osteotome, Plain End	6mm/8mm/12mm
8	23108.01-03	骨凿(滚花柄) Bone Osteotome, Semicircular End	6mm/8mm/10mm
9	23109.01-03	手指拉钩 Hook finger	小号/中号/大号
10	23110.01	尖钩 Sharp Hook	
11	23111.01	双齿拉钩 Skin Retractor	
12	23112.01	三齿拉钩 Three teeth retractor	
13	23113.01	四齿拉钩 Four teeth retractor	
14	23114.01-03	牵开器 Retractor	小号/中号/大号
15	23115.01-02	骨膜剥离器 Periosteum Detacher	小号/大号
16	23116.01	足踝撑开钳 Ankle Supporting Forceps	
17	23117.01	足踝克氏针撑开钳 Ankle Kirschner Wire Soreader Forceps	
18	23118.01	足踝克氏针压缩钳 Ankle Kirschner Wire Compression Forceps	
19	23119.01	足踝持骨钳 Ankle Bone Holding Forceps	
20	23120.01-02	多钩牵开器 Restrctor Self-Resatining Ratchet Type	直/弯
21	23121.01	单钩牵开器 Auto Restrctors	
22	23122.01-05	板材式骨刀 Osteotome	200*20/200*15/200*10/ 160*8/160*6
23	23123.01	器械盒 Instruments Box	

踝关节器械包
Ankle Instrument Set



23101.01
小力剪
Small Shear Force



23102.01
骨锤
Bone Hammer With Wood Handle
规格(Specifications): 350克



23103.01
尖嘴钳
Sharp-crested Clipper



23104.01
单关节咬骨钳
Single-Joint Bone Pliers
规格(Specifications): 180*2直



23104.02
单关节咬骨钳
Single-Joint Bone Pliers
规格(Specifications): 180*2弯



23105.01
带尖复位钳
Cusp Reduction Forceps



23106.01
骨锉
Bone File
规格(Specifications): 小号



23107.01-03
骨刀(滚花柄)
Bone Osteotome, Plain End
规格(Specifications): 6mm/8mm/12mm

踝关节器械包
Ankle Instrument Set



23108.01-03
骨凿(滚花柄)
Bone Osteotome, Semicircular End
规格(Specifications): 6mm/8mm/10mm



23109.01-03
手指拉钩
Hook finger
规格(Specifications): 小号/中号/大号



23110.01
尖钩
Sharp Hook



23111.01
双齿拉钩
Skin Retractor



23112.01
三齿拉钩
Three teeth retractor



23113.01
四齿拉钩
Four teeth retractor



23114.01-03
牵开器
Retractor
规格(Specifications): 小号/中号/大号



23115.01-02
骨膜剥离器
Periosteum Detacher
规格(Specifications): 小号/大号

踝关节器械包
Ankle Instrument Set



23122.01-05
板材式骨刀
Osteotome

规格(Specifications): 200*20/200*15/200*10/160*8/160*6



23116.01
足踝撑开钳
Ankle Supporting Forceps



23117.01
足踝克氏针撑开钳
Ankle Kirschner Wire Soreader Forceps



23118.01
足踝克氏针压缩钳
Ankle Kirschner Wire Compression Forceps



23119.01
足踝持骨钳
Ankle Bone Holding Forceps



23120.01
多钩牵开器
Restrictor Self-Retaining Ratchet Type
规格(Specifications): 直



23120.02
多钩牵开器
Restrictor Self-Retaining Ratchet Type
规格(Specifications): 弯



23121.01
单钩牵开器
Auto Restrictors

枪式复位钳
Gun Type Reduction Forceps

组合式系统: 三种不同复位臂均可连接于滑动装置上
Combined system: Three different reset arms can be connected to East China unit

四个方向上均可组装复位臂, 根据骨折类型灵活操作
Four directions can be assembled with the reset arm, according to the flexible operation of type of fracture



空心滑动杆可临时固定克氏针
The hollow sliding rod can be temporarily fixed with a needle

恒定、持续的应力传导
Constant and continuous stress conduction



复位臂
Reset Arm
规格(Specifications): 183mm

骨盆复位臂
Pelvis Reset Arm
规格(Specifications): 225mm

经皮微创复位臂
Minimally Invasive Percutaneous Reduction
规格(Specifications): 255mm

